

# NEC

## *i-Series*

### Multibutton Telephone Feature Handbook



# Your Multibutton Telephone

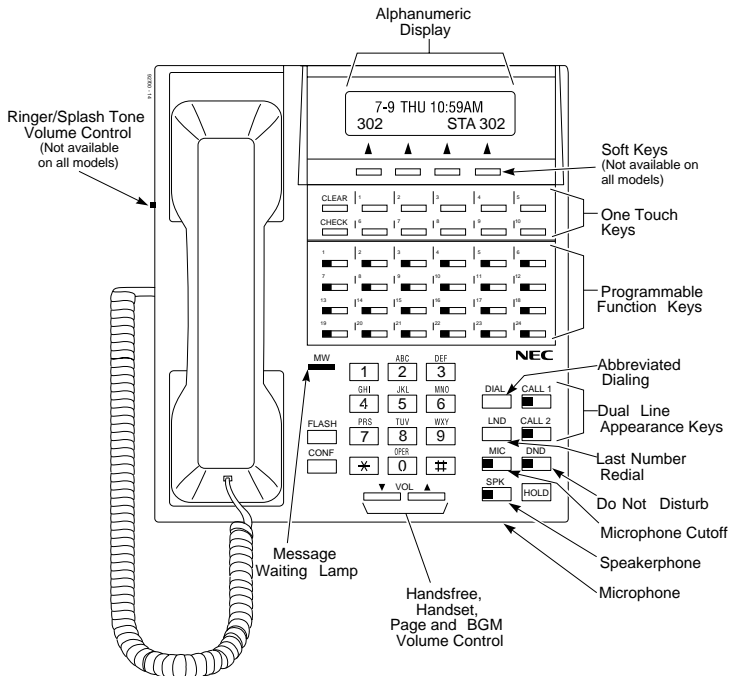

Nothing contained in this manual shall be deemed to be, and this manual does not constitute, a warranty of, or representation with respect to, any of the equipment covered. This manual is subject to change without notice and NEC America, Inc. has no obligation to provide any updates or corrections to this manual. Further, NEC America also reserves the right, without prior notice, to make changes in equipment design or components as it deems appropriate. No representation is made that this manual is complete or accurate in all respects and NEC America shall not be liable for any errors or omissions. In no event shall NEC America be liable for any incidental or consequential damages in connection with the use of this manual. This document contains proprietary information that is protected by copyright. All rights are reserved. No part of this document may be photocopied or reproduced without prior written consent of NEC America.

©2002 by NEC America, Inc. All Rights Reserved. Printed in U.S.A.

## Year 2000 Compliance

The 28i/124i/384i systems are unaffected by the date change to the year 2000. The systems process the Leap Year correctly and do not require any additional upgrades or reprogramming. All versions of the 28i use a four-digit date code entry. The 124i with software 4.04 EXCPU or Base 4.04 or higher uses a four-digit date code entry (e.g., 2000). Previous software versions use a two-digit date code entry (e.g. 00=2000). The 384i presently uses a four-digit year entry after software level 3.07.24.

# Table of Contents

---

<b>Using Your Telephone</b> .....	<b>1</b>
Handsfree Options .....	1
<b>Using All Those Features!</b> .....	<b>2</b>
Calling a Co-Worker .....	2
Outside Calls .....	2
Handling And Rerouting Your Calls .....	3
When Your Call Can't Go Through .....	3
Placing Calls Quickly .....	4
When You Work In Groups .....	5
If You Need Privacy .....	5
Have a Telephone Meeting .....	6
Streamlining Your Telephone's Operation .....	6
Personalizing Your Telephone .....	7
Your Phone Does the Talking .....	8
And, Your Super Display Does The Thinking .....	9
<b>Features</b> .....	<b>11</b>
Abbreviated Dialing .....	11
Account Codes .....	14
Alarm .....	15
Automated Attendant (VAU) .....	16
Background Music .....	17
Barge In .....	18
Call Forwarding .....	19
Call Forwarding Off-Premise .....	21
Call Forward Follow Me .....	22
Call Forward/DND Override .....	23
Call Timer .....	24
Call Waiting/Camp On .....	25
Callback .....	26
Caller ID .....	27
Conference .....	33
Conference, Voice Call .....	34
Department Calling .....	35
Department Step Calling .....	37
Dial Number Preview .....	38
Dial Pad Confirmation Tone .....	39
Directed Call Pickup .....	40
Directory Dialing .....	41

# Table of Contents

---

Do Not Disturb	.43
Door Box	.44
DSS Console	.45
Flash	.49
Forced Trunk Disconnect	.50
General Message	.51
Group Call Pickup	.52
Group Listen	.53
Handsfree and Monitor	.54
Headset Operation	.55
Hold	.56
System Hold	.56
Exclusive Hold	.57
Group Hold	.57
Intercom Hold	.57
Hotline	.58
Intercom	.59
Intercom Abandoned Call Display	.60
Last Number Redial	.61
Line Preference	.62
Meet Me Conference	.63
Meet Me External Conference	.63
Meet Me Internal Conference	.64
Meet Me Paging	.65
Meet Me External Paging	.65
Meet Me Internal Paging	.66
Memo Dial	.67
Message Waiting	.68
Microphone Cutoff	.70
Multiple Directory Numbers/Call Coverage	.71
Multiple Directory Numbers	.71
Call Coverage	.71
Name Storing	.72
Night Service	.74
Off Hook Signaling	.76
One-Touch Calling	.78
Using Personal Speed Dial without One-Touch Keys	.81
One-Touch Serial Operation	.82
Outside Calls, Answering	.84

# Table of Contents

---

Outside Calls, Placing . . . . .	86
Converting from Pulse to Tone Dialing . . . . .	87
Are You Behind a PBX? . . . . .	87
You May Have a Private Line . . . . .	88
If You Hear a Warning Tone . . . . .	88
How Prime Line Works . . . . .	88
Did Your Call Go Through? . . . . .	89
Paging . . . . .	90
Internal Paging . . . . .	90
External Paging . . . . .	90
Combined Paging . . . . .	91
Park . . . . .	92
Park and Page (VAU) . . . . .	94
Personal Greeting . . . . .	96
Programmable Function Keys . . . . .	98
Repeat Redial . . . . .	103
Reverse Voice Over . . . . .	104
When You're On a Call . . . . .	104
When Your Phone is Idle . . . . .	104
Ringdown . . . . .	105
Room Monitor . . . . .	106
Save Number Dialed . . . . .	107
Secretary Call . . . . .	109
Secretary Call Buzzer . . . . .	109
Secretary Call Pickup . . . . .	110
Selectable Display Messages . . . . .	111
Selectable Ring Tones . . . . .	113
Serial Call . . . . .	114
Tandem Trunking . . . . .	115
Method A . . . . .	115
Method B (Requires a <b>FUNCTION</b> [Transfer] key) . . . . .	116
Time and Date . . . . .	117
Transfer . . . . .	118
Transferring Outside Calls . . . . .	119
Transferring Without Holding . . . . .	119
Transferring Intercom Calls . . . . .	120
Meet Me External Paging Transfer . . . . .	121
Meet Me Internal Paging Transfer . . . . .	122
Trunk Queuing and Camp On . . . . .	123
Voice Announce Unit (VAU) . . . . .	124

# Table of Contents

---

Voice Mail	125
Calling Your Mailbox	126
Leaving a Message	126
Forwarding Calls to Your Mailbox	126
Emulating a Personal Answering Machine	127
Transferring Calls to a Mailbox	128
Recording Your Call	128
Voice Over	129
Voice Prompting Messages	130
Volume Controls	132
<b>Charts and Illustrations</b>	<b>133</b>

# Using Your Telephone

Your telephone's **Alphanumeric Display** helps you use features and tells you about your calls. For example, a ringing outside line may display a name before you answer it. (You may be able to change the time and date on your phone if it's not correct. Turn to page 117 for more.)

Press a **One-Touch Key** for one-button contact with co-workers and outside callers, or when using certain features. To learn how to program your One-Touch Keys, go to page 78.

**Function Keys** are normally line keys, but you can program them for other features. In this handbook, the feature assigned to a function key appears in parentheses next to the key. For example, **FUNCTION** (Hotline) means press the function key set for Hotline. See page 98 for more.

**Line Appearance Keys** are Intercom keys for placing and answering calls. If you're busy on one - just use the other.

Press  for Handsfree calls, or use the handset instead. See Handsfree Options below. The Microphone picks up your voice for Handsfree calls, while Feature Keys speed up using common features.

## Handsfree Options

- **Handsfree** lets you place and answer calls by pressing  instead of using the handset. Your telephone must have a Speakerphone if you want to use Handsfree.
- With **Automatic Handsfree**, press a line or Line Appearance key without lifting the handset. You normally have this feature.
- If you have **Monitor**, you can place a call without lifting the handset but you must lift the handset to speak. Telephones without Speakerphones have Monitor.

Due to the flexibility built into the system, your dialing codes may differ from those in this guide. Review Your System's Dialing Plan on page 133 and check with your Communications Manager.

Also, the system may restrict you from using some of the features in this handbook.

# Using All Those Features!

---

## Calling a Co-Worker

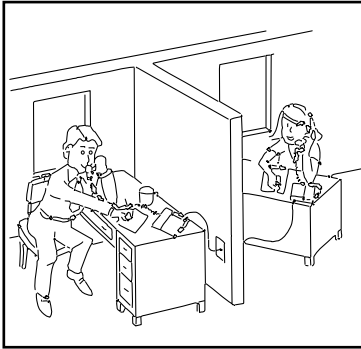

You can dial a co-worker on the **Intercom** (page 59), or use **Paging** (page 90) if you don't know where they are.

When you must get through right away, interrupt a call using **Barge In** (page 18).

Certain Intercom calls may ring your phone on function keys as **Multiple Directory Numbers** (page 71).

Visitors at your entrance door can call you on the Intercom using a **Door Box** (page 44).

## Outside Calls



You can **Answer Outside Calls** that ring your phone or flash your line keys (page 84). **Caller ID** allows you to identify the caller before or after you pick up the handset (page 27). **Night Service** (page 74) may change the way these same calls ring your phone. Set your **Line Preference** (page 62) to answer ringing outside calls or Intercom calls first.

To **Place Outside Calls** (page 86), use your line keys or dial codes. You may have to enter **Account Codes** (page 14) before your call goes through. Use **Dial Number Preview** (page 38) to check your digits before you dial. Once your call goes through, the **Call Timer** (page 24) shows you how long you're on the phone. You may be able to use **Flash** (page 46) to place another call without losing your line.



# Using All Those Features!

## Handling And Rerouting Your Calls

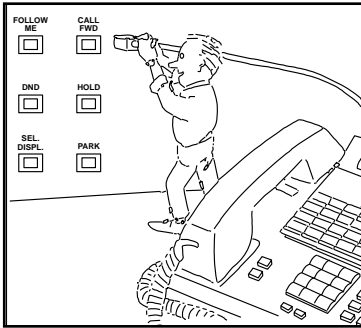

Use **Hold** (page 56) to have your call wait at your phone. Or, **Park** it in orbit for a co-worker (page 92).

Have a call for a co-worker? **Transfer** it to them (page 118). Don't know where they are? Use **Meet Me Paging Transfer** (page 121) so they can pick it up wherever they are. If you want the call to come back when your co-worker is done, use **Serial Call** (page 114).

When you leave your desk, think about **Call Forwarding** your calls to someone else (page 19). If that meeting runs long, go to another phone and bring your calls to you with **Call Forward Follow Me** (page 22). When you want callers to know where you are, set a **Selectable Display Message** at your phone (page 111). You may be able to **Override** (page 23) another user's Call Forward if you think they are still at their phone.

## When Your Call Can't Go Through

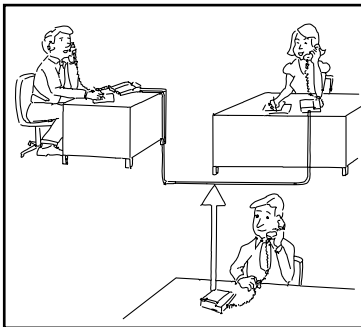

Don't just hang up when your call can't get through to a co-worker! Use **Call Waiting** (page 25) to wait without hanging up. Send your co-worker **Off Hook Signaling** (page 76) to let them know you're waiting. If you don't have time to wait, leave a **Callback** request (page 26).

In a hurry? Think about leaving your co-worker a **Message Waiting** (page 68), or use optional **Voice Mail** (page 125) to record a voice message for them.

# Using All Those Features!

---

There's no need to keep redialing your outside call if it's busy or unanswered - use **Repeat Redial** instead (page 103). And when your system's lines are busy, **Trunk Queuing** (page 123) lets you wait for a free one. If you have an emergency, **Forced Trunk Disconnect** (page 50) allows you to get through on a busy line right away.

With **Voice Over** (page 129), talk to a busy user - while they keep talking to their initial caller. When you're busy on a call, you can do the same thing with **Reverse Voice Over** (page 104).

## Placing Calls Quickly

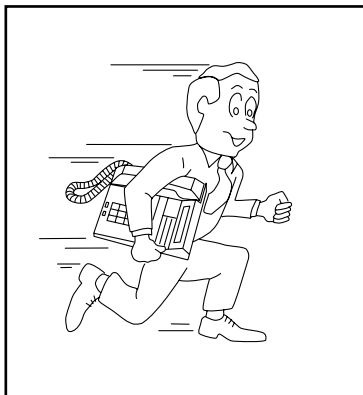

Store numbers that you call often in **Abbreviated Dialing** bins (page 11). You can easily dial the stored number with just a few key presses. To quickly retry the number you just dialed, try **Last Number Redial** (page 61). If you'll need to redial the number later on, let **Save Number Dialed** (page 107) retain it for you. Ever call Directory Assistance for a number and not have a pen to write it down? Use **Memo Dial** (page 67)

to jot the number down in your phone's memory instead.

# Using All Those Features!

## When You Work In Groups

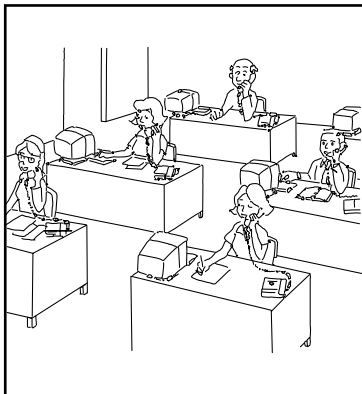

If you and your co-workers handle each other's calls, you might want to be in a **Department Calling** group (page 35). Someone calling your group's number goes through to anyone who's available. You can even have **Department Step Calling** (page 37) send your personal calls to your group when you're not available. To answer a call already ringing a co-worker's phone, use **Group Call Pickup** (page 52).

When you're on a call and you want the others in your area to listen in on the conversation, activate **Group Listen** (page 53). Your co-workers hear the call through your telephone's speaker.

If you frequently call the same co-worker, you can have **Ringdown** (page 105) automatically call them for you. All you have to do is lift your handset.

## If You Need Privacy

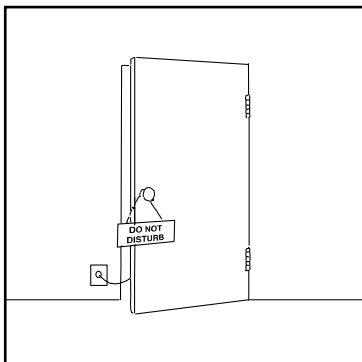

When you're busy in your office and don't want to be interrupted, use **Do Not Disturb** (page 43).

Before talking to someone at your desk while you're on the phone, try **Microphone Cutoff** (page 70). Your caller cannot hear your voice until you cancel Microphone Cutoff.

# Using All Those Features!

---

## Have a Telephone Meeting

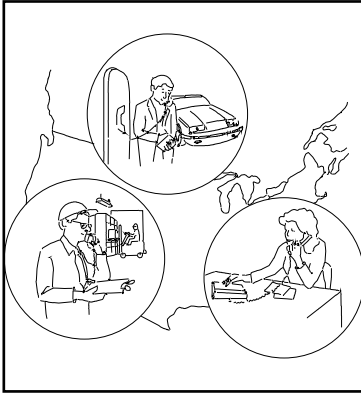

**Conference** (page 33) allows you to quickly set up a telephone meeting. When your phone allows **Voice Call Conference** (page 34), others can join your outside call just by pressing the line key.

Use **Meet Me Conference** (page 63) to set up a meeting which lets others join if they choose. Optionally, you can use **Meet Me Paging** (page 65) to set up a meeting on a page zone.

To join two *outside* callers together and leave them to talk privately, use **Tandem Trunking** (page 115).

## Streamlining Your Telephone's Operation

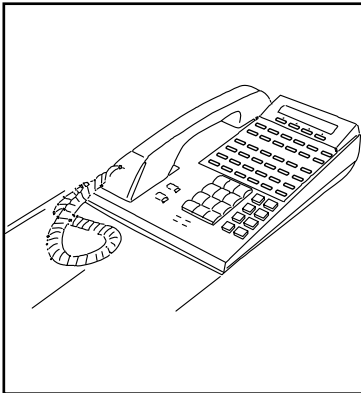

Your telephone provides you with options that can dramatically streamline the way you handle calls. For example, you can program **One-Touch Keys** (page 78) for one-button access to co-workers, outside calls, Abbreviated Dialing bins and certain feature codes. Or record any dialing steps in a one-touch "macro" key with **One-Touch Serial Operation** (page 82).

Want to automate Callback, Message Waiting or other features? Just assign these functions to available **Programmable Function Keys**

# Using All Those Features!

(page 98). Need one-button Transfer and calling for a co-worker? Program a Hotline (page 58) on another function key. (When you see **FUNCTION** in this handbook, the operation needs a Programmable Function Key.)

Are you a secretary - or do you have a secretary that handles your calls? Set up **Secretary Call** buzzer keys (page 109). You can use **Secretary Call Pickup** (page 110) to quickly pick up calls intended for your secretary or boss.

Tired of always reaching for the handset or cradling it under your chin while you type? Install a headset and enable **Headset Operation** (page 55).

## Personalizing Your Telephone



If your phone is near other phones that ring the same way, choose unique **Selectable Ring Tones** (page 113) so you know which calls are for you.

When you need to cover up noise in your office that might be distracting to your work, turn on **Background Music** (page 17).

Don't forget about that important meeting - set an **Alarm** (page 15) to remind you.

Let the co-workers you call know who's on the line. Go to **Name Storing** (page 72) and assign a name to your extension.

To have your phone beep every time you press a dial pad key, enable the **Dial Pad Confirmation Tones** (page 39).

# Using All Those Features!

---

## Your Phone Does the Talking

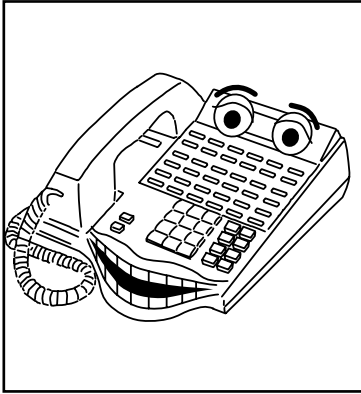

The optional **Voice Announce Unit** (page 124) gives your system digital recording and play back capability. This lets you handle callers with that important "Personal Touch". For example, if you don't have an operator, the **Automated Attendant** (page 16) can answer your calls and play a list of dialing options to your callers. Use **Personal Greeting** (page 96) to greet your callers with your own recorded voice, and then

forward them to a co-worker. Or, you can have **Park and Page** (page 94) welcome your callers and automatically page you to pick up the call.

You'll find other Voice Announce Unit features handy when using your phone or staying in touch with others in your company. If there is an announcement everyone in your company should hear, just listen to your **General Message** (page 51). **Voice Prompting Messages** (page 130) tell you about your system, your own phone and the status of your call. You'll hear voice prompts reminding you when your calls are forwarded or when you have a message. You can even find out your extension number, the date and the time of day.

# Using All Those Features!

## And, Your Super Display Does The Thinking

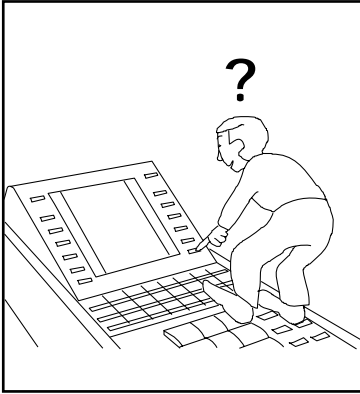

Do you want a feature but not know how to use it? Have you ever been busy on a call and not remembered the options your phone provides? If you have an optional *Super Display Telephone*, the Soft Keys on your telephone do the thinking for you.

When you use your Super Display, your One-Touch Keys automatically turn into Soft Keys. A Soft Key is a variable feature key - *the function of the key changes to match what you are doing*. This lets you spend more time thinking about your job and less time thinking about your telephone.

The example on the next page shows how this works. In this example, you are busy on an outside line talking to a customer. You realize that you want to call this customer again, but can't remember the name of the feature that lets you save the number.

### Here's what you do:

1. **MENU** (Press the MENU Soft Key).  
*This is the top screen in the illustration on the next page.*

2. **SAVE DIAL** (Press the SAVED DIAL Soft Key).

*This is the second screen in the illustration on the next page.*

*The system saves the number you just dialed and returns your Soft Keys to One-Touch Keys. This is the last screen in the illustration on the next page.*

# Using All Those Features!

To find out more on using your Soft Keys, use the plastic laminated Reference Card that came with your phone.

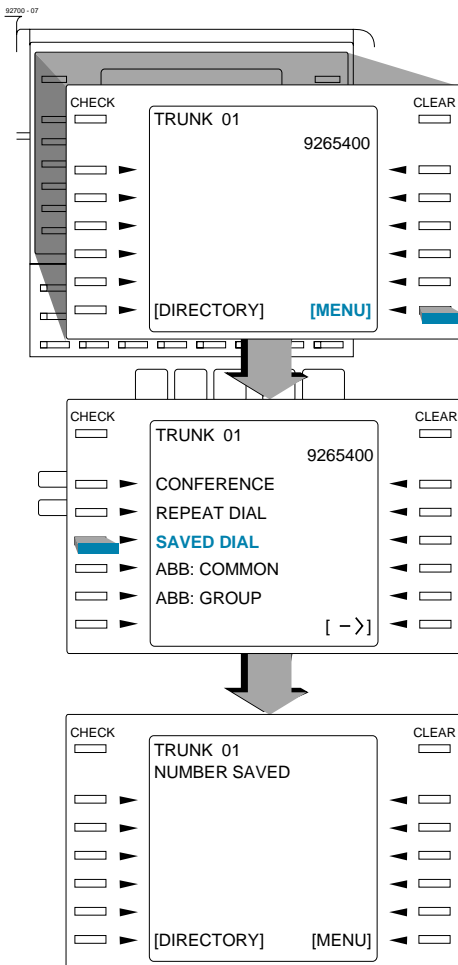













# Abbreviated Dialing

Abbreviated Dialing gives you quick access to numbers you call frequently. This saves time, for example, when calling a client with whom you deal often. Instead of dialing a long telephone number, you just use Abbreviated Dialing.



There are three types of Abbreviated Dialing: Common, Group and Personal. All co-workers within your Tenant Group can share the Common Abbreviated Dialing numbers. All co-workers in your Department Calling Group can share the Group Abbreviated Dialing numbers. (See page 35 for more on Department Calling.) Only you can use your Personal Abbreviated Dialing numbers. To set up Personal Abbreviated Dialing, turn to One-Touch Calling on page 78.

To store an Abbreviated Dialing number (recommended for display phones only):

1.  +    (for Common).  
*OR*  
   (for Group).
2. Dial Abbreviated Dialing bin number (000-499 or 0000-1999).  
*Ask your Communications Manager for your bin numbers.*
3. Dial telephone number you want to store (up to 24 digits).  
*Valid entries are 0-9, # and \*. To enter a pause, press MIC.*
4.  + Enter the name associated with the Abbreviated Dialing number.  
*Refer to Name Storing on page 72 for instructions on entering names.*
5.  +  to hang up.

# Abbreviated Dialing

To dial a Common Abbreviated Dialing number:

1.  +  .
2. Dial bin number.

*The stored number dials out. The system selects a line for you.*

**OR**



1.  +  or  (Common Abbreviated Dialing).
2. Dial Common Abbreviated Dialing bin number.

*To preselect, press a line key instead of CALL1.*

2. Dial Common Abbreviated Dialing bin number.

*The stored number dials out. Unless you preselect, the system selects a line for you.*

To dial a Group Abbreviated Dialing number:

1.  +  .
2. Dial bin number.

*The stored number dials out. The system selects a line for you.*

**OR**

1.  +  (Group Abbreviated Dialing).
2. Dial Group Abbreviated Dialing bin number.

*To preselect, press a line key instead of CALL1.*

2. Dial Group Abbreviated Dialing bin number.

*The stored number dials out. Unless you preselect, the system selects a line for you.*

# Abbreviated Dialing

---

To check your stored  
Abbreviated Dialing  
numbers:

1.
2.  (Common only).
3. Dial the Abbreviated Dialing code (e.g., 001).

*If the entire stored number is too long for your phone's display, press \* to see the rest of it.*

*To check more Abbreviated Dialing numbers, repeat from step 2.*

4.

# Account Codes

---

Account Codes are codes you enter that help keep track of outside calls. There are two types of Account Codes: Optional and Forced. With optional codes, the Account Codes you enter are solely for categorizing your calls. For example, if you work in an accounting firm that must bill back customers for time on the phone, Optional Account Codes are for you. Forced Account Codes also let you categorize calls, but you must enter one before placing outgoing calls. If you don't enter the code, you can't place the call. This ensures that calls don't go out untracked.

Check with your Communications Manager to find out if your system uses Account Codes - and which codes you should enter. Account Codes can be from 1-16 digits long, using 0-9 and #.

To enter an Account Code any time while on an outside call:

1.  + Account Code (1-16 digits) + .

To enter an Account Code while placing an outside call:





1. Access trunk for outside call.  
*You can access a trunk by pressing a line key or by dialing a code. Refer to page 86 for more on placing outside calls.*
2.  + Account Code (1-16 digits) + .
3. Dial the number you want to call.  
*If you hear "stutter" dial tone after dialing the number, your system requires an ARS Authorization Code. Ask your Communications Manager for your codes.*

# Alarm

You can use your extension like an alarm clock to remind you of appointments and important meetings. Your phone has two types of alarms:

- Alarm 1 - which sounds only once at the preset time.
- Alarm 2 - which sounds every day at the preset time.





To set the alarm:

1.  +    + Alarm type (1 or 2).
2. Dial the alarm time (24-hour clock).  
*For example, for 1:15 PM dial 1315.*
3.  to hang up.









To silence an alarm:

1. 

To check the programmed alarm time:

1.  +    + Alarm type 1 or 2 + .

To cancel an alarm:

1.  +    + Alarm type 1 or 2.
2.     +  to hang up.

# Automated Attendant (VAU)

☞ This feature requires a Voice Announce Unit (VAU).

Automated Attendant automatically answers your system's outside calls, plays a prerecorded greeting and then lets callers directly dial you or your co-workers. This gives your system immediate answering and routing of calls without an operator or dispatcher. The Automated Attendant can:

- Simultaneously answer up to six calls.
- Route calls to an extension, Department Group or Voice Mail and provide additional options if the extension or group is unavailable.
- Give you the option of recording or modifying the Automated Attendant greetings (see below).

To record, listen to or erase an Automated Attendant greeting:

1.  +   .

2. To record, dial .

**OR**

To listen, dial .

**OR**

To erase, dial .

3. Dial the VAU message number (01-16) for the Automated Attendant greeting you want to record, listen to or erase.

*Your Communications Manager can tell you which message to enter.*

*If recording, begin when you hear the announcement, "Please start recording." When done, press # to check what you recorded.*

*When listening to a message, press # to hear the message again.*





*If erasing, you can cancel erasing by pressing HOLD before hanging up.*

4.  to hang up.

# Background Music

Background Music (BGM) sends music from an FM receiver, tape deck or CD player your company provides to the speaker in your telephone. This helps give you a pleasant working environment. The Background Music plays whenever your phone is idle.

To Turn BGM on or off:

1.  +   .
2.  to hang up.

# Barge In

---

Barge In permits you to break into a co-worker's established call. Use Barge In when you have to get a message through right away (such as in an emergency). Barge In sets up a three-way call between you, your co-worker and their caller.

Your system provides two Barge In modes: Monitor Mode and Speech Mode. With Monitor Mode, you can listen in on another user's conversation but you cannot participate. With Speech Mode, you can listen and join into the conversation. Check with your Communications Manager to see which type of Barge In you have.

CAUTION
Unauthorized intrusion on calls using the Barge In feature may be interpreted as an invasion of privacy.

- To Barge In on a conversation in progress:
1. Call busy extension.
  2. **FUNCTION** (Barge In).





# Call Forwarding

Use Call Forwarding to redirect your calls to another extension. With Call Forwarding, you're sure your calls are covered when you are away from your work area. There are four types of Call Forwarding:

- **Call Forwarding when Busy or Not Answered**  
Calls forward when your extension is busy or not answered.
- **Call Forwarding Immediate**  
All calls forward immediately to the destination, and only the destination rings.
- **Call Forwarding when Not Answered**  
Calls forward when your extension is not answered.
- **Call Forwarding Immediate with Both Ringing**  
All calls forward immediately to the destination, and both the destination and your extension ring (not for Voice Mail).
- **Personal Answering Machine Emulation**  
Have your phone emulate an answering machine. Turn to page 125 for more on Voice Mail.

Call Forwarding will reroute calls ringing your extension, including calls transferred from another extension. You must enable Call Forwarding from your phone. To redirect your calls if you are at another phone, use Call Forward Follow Me on page 22.

To activate or cancel  
Call Forwarding:

1.  +  

**OR**



 (Call Forward to Station).

2. Dial Call Forwarding condition:
  - 1 = Personal Answering Machine Emulation (then skip to step 4)
  - 2 = Busy or not answered
  - 4 = Immediate
  - 6 = Not answered
  - 7 = Immediate with simultaneous ringing (not for Voice Mail)
  - 0 = Cancel

# Call Forwarding

---



## To activate or cancel Call Forwarding (Cont'd):

3. Dial destination extension, Voice Mail master number or press Voice Mail key.  
*You cannot forward to a Department Group pilot number. Once you forward, only the destination user can place an Intercom call to you.*
4. Dial Call Forwarding type:  
2 = All calls  
3 = Outside calls only  
4 = Intercom calls only
5.  to hang up (if you dialed   
 in step 1).  
*Your DND or Call Forwarding (Station) Programmable Function Key flashes when Call Forwarding is activated.*

# Call Forwarding Off-Premise

Use Off-Premise Call Forwarding to forward your calls to an off-site location. Stay in touch when you're away from the office by forwarding to your cellular phone, home office, hotel or meeting room.

To activate Call Forwarding Off-Premise:

1.  +  .

**OR**

1.  (Call Forward to Device).

2.  + Dial line access code.

*Line access codes are 9 (ARS/Trunk Group Routing), 804 + Line Group (1-9, 01-99 or 001-128) or #9 + Line number (e.g., 05 or 005 for line 5).*



3. Dial the outside number to which your calls should be forwarded.

4. .

5.  to hang up (if you dialed \*4 in step 1).



*Your DND or Call Forwarding (Device) Programmable Function Key flashes.*

To cancel Call Forwarding Off-Premise

1.  +  .

**OR**

1.  (Call Forward to Device).

2.  + .

3.  to hang up (if you dialed \*4 in step 1).

*Your DND or Call Forwarding (Device) Programmable Function Key stops flashing.*

# Call Forward Follow Me

While you are at a co-worker's desk, you can direct your calls to your co-worker's extension. Use Call Forward Follow Me if you get detained with your co-worker longer than expected. Instead of ringing your own phone unanswered, your calls will ring you where you are. (To reroute calls from your own extension, use Call Forwarding on page 19.)

To activate Call Forward Follow Me:

1. +

**OR**

1. (Call Forward to Station).

2. + Dial your own extension number (i.e., the source).

3. Dial Call Forwarding type:

2 = All calls

3 = Outside calls only

4 = Intercom calls only

4. to hang up (if you dialed

in step 1).

*Your Call Forwarding (Station) Programmable Function Key flashes when Call Forwarding is activated.*

To cancel Call Forward Follow Me:

1. +

**OR**

1. (Call Forward to Station).

2.

3. to hang up (if you dialed in step 1).

*Your Call Forwarding (Station) Programmable Function Key goes out.*

# Call Forward/DND Override

---

If you call an extension that is Call Forwarded or in Do Not Disturb, use Call Forwarding/DND Override to talk to the extension user anyway. This is helpful, for example, if you have an important message or emergency and you must get through.

- To override an extension:**
1. Call the forwarded or DND extension.
  2. **FUNCTION** (Override).

# Call Timer

---

You can time your outside calls on your telephone display. You'll find Call Timer indispensable if you must keep track of your time on the phone. For incoming calls, the Call Timer begins as soon as you answer the call. For outgoing calls, the Call Timer starts about 10 seconds after you dial the last digit.

To time your outside  
calls:

1. Place or answer the outside call.  
*The Call Timer starts automatically.*

# Call Waiting/Camp On

After you call a busy extension, use Call Waiting to wait in line (i.e., Camp On) without hanging up. When you Camp On, the system signals the busy user indicating that you are waiting. Your call goes through when the busy extension becomes free.

Call Waiting also helps when you are on the phone because it lets you know when additional calls are trying to get through. Call Waiting lets your callers wait in line without being forgotten.

**Note:** When you call a busy attendant, your call will normally "stack up" in queue behind other waiting callers.

## To Camp On to a busy extension:

1. Call the busy extension. You must hear busy tone.

2.  or  (Camp On).

3. Wait without hanging up.

*Your Camp On Programmable Function Key lights while you wait.*

*If you hang up, the system converts your Camp On to a Callback (see page 26).*

*To Camp On to a trunk, see the Trunk Queuing feature on page 123.*

## To cancel a Camp On request:

1. Hang up.

*If you skip step 2, the extension will call you back when it becomes free.*

2.  +   .

**OR**

2.  (Camp On).

*Your Camp On Programmable Function Key goes out.*



# Callback

When you call a busy extension, you can leave a Callback request for a return call. You do not have to repeatedly call the busy extension back, hoping to find it idle. When you leave a Callback, the system handles your request as follows:

- When the busy extension becomes idle, the system rings you.
- After you answer the Callback ring, the system then rings the formerly busy extension. (If that extension doesn't answer, the system cancels the Callback.)
- As soon as the other extension answers, the system sets up an Intercom call between you and them.





If your phone has Automatic Callback, you answer the Callback ring as soon as you lift the handset. If your phone doesn't have Automatic Callback, you must press the ringing line appearance key to answer the Callback ring.

## To place a Callback:

1. Call a busy extension.
2.  or  (Callback).
3. Hang up.
4. Lift handset when busy extension calls you back.

*If you don't have Automatic Callback, you'll have to press the ringing Line Appearance key.*

## To cancel a Callback:

1.  +   .  
**OR**  
 (Callback).





# Caller ID

Caller ID allows a display keypad to show an incoming caller's telephone number (up to 12 digits) and optional name. The Caller ID information can be displayed either before or after answering a call. Normally, the system provides the Caller ID pre-answer display. With the pre-answer display, you can preview the caller's number before picking up the ringing line. Your Communications Manager can tell you which option you have. This information is stored in Caller ID bins.



Display telephone users have the ability to check the identity of an incoming call while they are currently busy on a call. The type of information that displays will depend on the type of call being received. Intercom calls will display station names, while incoming trunks calls will display Caller ID, ANI or the name assigned to the line. Depending on the system programming, this information can be displayed either automatically or manually.

Caller ID will temporarily store 16 calls (this included abandoned or unanswered calls). New calls replace the old calls when the maximum number of calls is reached.

To display Caller ID for calls only lamping your phone or not automatically displayed (*with Automatic Handsfree*):

1. Press  +  .  
*If the Caller ID data includes the name, you can scroll left and right by pressing \* and #.*
2. Press  to answer the call.

To display Caller ID for calls lamping your phone or not automatically displayed (*without Automatic Handsfree enabled*):

1. Do not lift the handset and press  .  
*If the Caller ID data includes the name, you can scroll left and right by pressing \* and #.*
2.  or press  to answer the call.

# Caller ID

## To Automatically Add New Numbers to the Caller ID Table:

You can store the Caller ID data in the system's Caller ID Table or in one of your One Touch keys.

1. Press **FUNCTION** (Caller ID Edit).
2. **To store a number in a One Touch key:**

Dial <sup>PGRS</sup> **7** (Personal) + Press <sup>DIAL</sup> **[ ]** + Press One Touch key that will store the Caller ID information + (Optional - if name is not sent from telco) If you see ENTER NAME, enter the name you want to associate with the stored number.

### **To store a number in a Common Abbreviated Dialing Bin:**

Dial <sup>ABC</sup> **2** (Company) + Press <sup>DIAL</sup> **[ ]** + Dial the bin number in which you want to store the number (0-999) + (Optional - if name is not sent from telco) If you see ENTER NAME, enter the name you want to associate with the stored number.

*You cannot edit a name if it was sent from the telco.*

Press <sup>DND</sup> **[ ]** to toggle between upper and lower case letters.

*For information on entering names, refer to the Name Storing feature.*

*When entering information into the company Caller ID Table, if the table is full, you will see a TABLE IS FULL*

*message after pressing <sup>ABC</sup> **2** (Company).*

## To Manually Add New Entries to the Caller ID Table:

1. Press
2. Dial    or press  (Caller ID Edit).
3. Dial  (New).

*If you see TABLE IS FULL, you cannot add any more entries to the Caller ID Table.*

4. Enter the number you want to add to the Caller ID Table.

*For wild card entries, press FLASH. This allows you to associate several phone numbers with the same name. For example, 926-540(FLASH) would associate all numbers from 5400-5409 with the same name.*

5. Press .
6. Enter the name to be assigned to the number.  
*Refer to the Name Storing feature for help on entering a name.*
7. Press .
8. Return to Step 3 to add another number to the table or press  to exit.

## To Manually Change an Entry in the Caller ID Table:

1. Press .
2. Dial    or press  (Caller ID Edit).
3. Dial  (Change).

# Caller ID

## To Manually Change an Entry in the Caller ID Table (Cont'd):

### 4. **To find a name entry in the Table:**

- Dial  <sup>WXYZ</sup>.
- Enter the name you want to change and press .

*The system finds the first name that matches the letters you entered.*

**OR**

### **To find a number entry in the Table:**

- Dial  <sup>MNO</sup> (No).
- Dial the number you want to change and press .
- Re-enter the highlighted number and press  when you are done. You return to Step 3.

*You can quickly edit the name for the selected number by pressing .*

5. Press  to exit.

## To Manually Delete an Entry in the Caller ID Table:

1. Press .
2. Dial    <sup>GH MNO</sup> or press  (Caller ID Edit).
3. Dial  <sup>DEF</sup> (Delete).
4. **To delete a number in the Table:**

- Dial  <sup>WXYZ</sup>.

## To Manually Delete an Entry in the Caller ID Table (Cont'd):

- Enter the name you want to delete and press **HOLD**.

*The system finds the first name that matches the letters you entered. To search for other names with the same letters, press ▼ **VOL** and **VOL** ▲.*

*If you see NO MATCH, the name doesn't exist.*

- To delete the name, press **HOLD**.

- Dial <sup>WXYZ</sup>**9** to confirm the deletion or

dial <sup>MNO</sup>**6** to cancel. In either case, you return to Step 3.

*You can quickly edit the number for the selected name by pressing CHECK.*

**OR**

### **To delete a number in the Table:**





- Dial <sup>MNO</sup>**6** (No).
- Dial the number you want to delete and press **HOLD**.
- When you find the number you want to delete, press **HOLD**.

- Dial <sup>WXYZ</sup>**9** to confirm the deletion or dial <sup>MNO</sup>**6** to cancel. In either case, you return to Step 3.



*You can edit the name for the selected number by pressing CHECK.*

# Caller ID

To check if any Caller ID calls rang your phone while you were away from your desk:

1. Press .
2. Dial   . If you missed any calls, the displays shows MISSED CALL C:2 E:3

*The second row of your display shows the Caller ID number you missed. To see the name (if sent from the telco), press CHECK.*

*If you missed more than one call, press  and  to see the list.*

3. To call the displayed number, dial .



**OR**

To erase the displayed number without

returning the call, dial .

4. Press  to hang up.

To manually display caller information for a second call:

1. While on a call with a second call ringing in, press  and then press the flashing .

*The display indicates the caller information.*



2. To clear the display, either press CLEAR or it will clear on it's own.

# Conference

Conference lets you add additional inside and outside callers to your conversation. With Conference, you can set up a multiple-party telephone meeting without leaving the office. The system allows either four or eight parties maximum per Conference.

In addition to Conference, there are other ways to have a telephone meeting. See Voice Call Conference (page 34), Meet Me Conference (page 63), Meet Me Paging (page 65) and Tandem Trunking (page 115).

## To set up a Conference:

1. Place or answer call.
2.  or  (Conference).
3. Place or answer next call.

*To access the outside call, either press  or dial a trunk access code. See Outside Calls on pages 84 and 86 for more.*

4.  or  (Conference).

*You may be able to have up to 32 callers. Repeat this step to add more parties.*

5. After adding all parties, press  again to begin the Conference.

## To exit a Conference (without affecting the other parties):

1.  to hang up.

*You can set up a Conference with two outside callers and then drop out of the call - leaving the callers talking in an Unsupervised Conference. Refer to Tandem Trunking on page 115 for more.*

# Conference, Voice Call

---

With Voice Call Conference, others in your work area can easily join into your outside calls. To initiate a Voice Call Conference, press a uniquely programmed Voice Call Conference key and tell your co-workers to join the call. The system releases the privacy on the line, and other users can just press the line key to join in. The system allows either four or eight parties maximum per Conference. Voice Call Conference does not use the telephone system features to announce the call. You just announce it "through the air" to your co-workers.

In addition to Voice Call Conference, there are other ways to have a telephone meeting. See Conference (page 33), Meet Me Conference (page 63), Meet Me Paging (page 65) and Tandem Trunking (page 115).

To set up a Voice Call Conference with a co-worker in your immediate work area:

1. Place or answer trunk call.
2. **FUNCTION** (Voice Call Conference).
3. Announce Voice Call Conference.

*Just tell your co-worker's about the call. Do not use telephone system features to announce it.*

To join a Voice Call Conference (if invited):

1. After Conference request, press indicated line key ( **LINE** ).

To exit a Voice Call Conference without affecting the other parties:

1.  to hang up.



# Department Calling

If you work closely with a group of co-workers, your Communications Manager may have programmed you into a Department Calling Group. Department Calling makes it easier for others in your company to send calls to your group. This is because your Department Calling Group has a dedicated pilot number. To get a free group member, co-workers can just dial the pilot number instead of the group member's extensions. If you don't want to receive Department Calls, you can log out of your group. You can log back in when you again want to receive calls.

Calls into your Department Group can route in two different ways: Priority Routing and Circular Routing. With Priority Routing, incoming calls route to your group's highest priority extensions first.

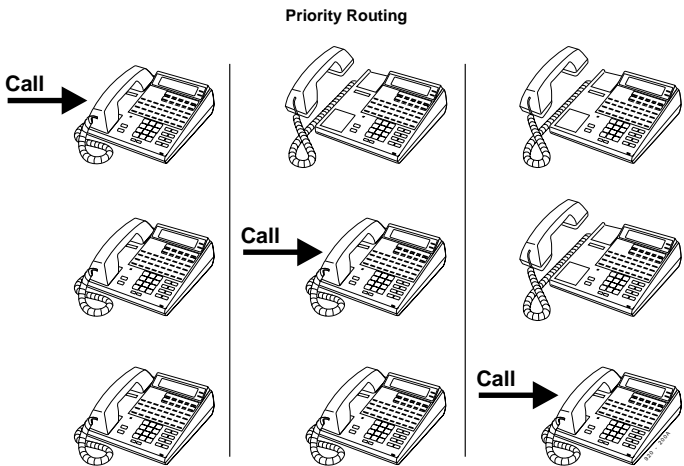

# Department Calling

With Circular Routing, each call rings a new extension.

Circular Routing

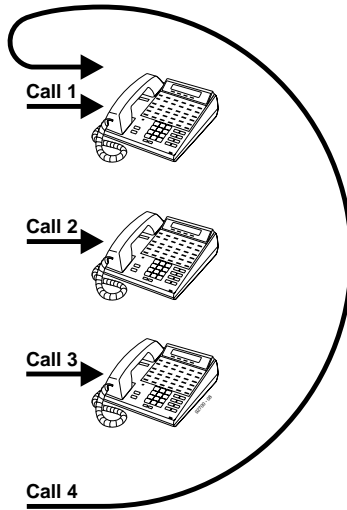

To call a Department Group:

1.  + Department Group pilot number.

To log out of your Department Group:

1.  +    + .
- OR**

(Department Group log out).

*The key lights while you are logged out.*

To return to your Department Group:

1.  +    + .
- OR**

1.  (Department Group log out).

*The key goes out when you log back in.*

# Department Step Calling

---



If you place an Intercom call to a busy Department Group member, Department Step Calling allows you to quickly call another member in the same group. You don't have to hang up and place another Intercom call. You can also use Department Step Calling to cycle through the members of a Department Group.

## To make a Step Call:

1. Place call to busy Department Group member.

***OR***



Place call to Department Group pilot number.

2.  or  (Step Call).
3. Repeat step 2 to call other Department Group members.

# Dial Number Preview

Use Dial Number Preview to preview a number in your telephone's display before you dial it out. This helps you avoid dialing errors. For example, if you review the previewed number and find an error, you can cancel the number and re-enter it correctly. Dial Number Preview is available for both outside and Intercom calls.

To use Dial Number Preview to place a call:

1. Do not lift handset or press .
2.  + Number you want to preview.
3.  to dial out the displayed number. If the displayed number is an outside number, it must contain a line access code.

**OR**

 to cancel the number without dialing it out.

**OR**

 to dial out the displayed outside number on the selected line.

*If your previewed outside number has a trunk access code (e.g., 9), you can*

*press  instead.*





*The system will not automatically strip out a trunk access code when you press a line key.*

# Dial Pad Confirmation Tone

---

When you enable Dial Pad Confirmation Tone for your extension, you hear a beep each time you press a dial pad key. This beep reminds you that you have pressed a key. The confirmation tone is particularly helpful for Intercom calls and calls on Dial Pulse lines. For these types of calls, you don't hear tones echoed back to your handset or speaker to confirm your dialing.

To enable or disable  
Dial Pad Confirmation  
Tone:



1.  +   .  
*You hear confirmation beeps.*
2.  to hang up.

# Directed Call Pickup

---

Use Directed Call Pickup when you need to answer a call ringing another extension without leaving your phone. This lets you easily cover a co-worker's calls when they have to be away from their desk.

To intercept calls ringing a co-worker's phone:

1.  or  .

2.   .

3. Dial your co-worker's extension number.





# Directory Dialing

If you have a Display or Super Display phone, Directory Dialing allows you to select a co-worker or outside number from a list of names, rather than dialing the phone number. There are four types of Directory Dialing:



- C** - Company (Common) Abbreviated Dialing
- D** - Department (Group) Abbreviated Dialing
- P** - Personal Abbreviated Dialing (One-Touch Keys)
- X** - Co-worker's extension

Directory Dialing follows any feature restrictions that your system may have enabled. For example, if your extension cannot normally use Common Abbreviated Dialing, Directory Dialing can't access it either.

To use Directory Dialing from a display keyset:

1. Do not press  or .
2.  or  (Directory Dialing).  
*If you wait too long between your selections, Directory Dialing automatically cancels.*
3. Dial the type of Directory Dialing from the table below:

2 (C)	=	Company (Common Abbreviated Dialing)
3 (D)	=	Department (Group) Abbreviated Dialing
7 (P)	=	Personal Abbreviated Dialing (One-Touch Keys)
9 (X)	=	Extensions

*If you dial 7 from a Super Display keyset, your One-Touch Key names will display. Pressing  or  scrolls through the names in key number order (not alphabetically).*

4. Dial the first letter/number for the name/number you want to call.

# Directory Dialing

To use Directory Dialing from a display keyset (Cont'd):

*For example, dial 2 if the name begins with A, B, C or 2.*

*If the name begins with Q or Z, dial 0.*

5. Look at your phone's display and dial the digit for the letter/number selected in step 4 above.

*For example, if you dialed 2 in step four, you'll see: 1=A 2=B 3=C 4=2.*

*You'll want to dial 1 to select the letter A, 2 to select B and so on.*





*The first name/number that begins with your selection displays.*

*If you see, "UNLISTED NAME," there is no name stored for your selection.*

*If you have a Super Display keyset, the first 10 numbers that match your selection will display. To see the next 10 matches, press [SCROLL]. To see the previous 10 matches, press [->].*

6. Press ▼ [VOL] or [VOL] ▲ to scroll through all the names/numbers that begin with that letter/number.

**OR**

 or press ,  or  to place the selected call.

To cancel Directory Dialing:

1. Press .

To review your Directory Dialing entries while on a call:

1. Press  (Directory Dialing).



# Do Not Disturb

Do Not Disturb (DND) blocks incoming calls, Call Forwards and Paging announcements to your extension. DND permits you to work undisturbed at your desk without interruptions from your phone. When you activate DND, incoming calls still flash your line keys. While in DND, you may use your phone in the normal manner for placing and processing calls.

There are four Do Not Disturb options:

Do Not Disturb Options	
<b>1</b>	Blocks your outside calls
<b>2</b>	Blocks Paging, Intercom calls, Call Forwards and transferred outside calls
<b>3</b>	Blocks all calls
<b>4</b>	Blocks Call Forwards
<b>0</b>	Cancels Do Not Disturb

To activate or deactivate Do Not Disturb:

1. Do not lift the handset.

2. 

**OR**

 +  **8**  **4**  **7**.

*If you wait more than 10 seconds before going to step 3, your system automatically enables option 3. If you already have DND enabled, waiting more than 10 seconds cancels it.*

3. Dial the DND option code (0-4).

# Door Box





---

Your system may have Door Boxes. A Door Box is a self-contained Intercom unit typically used to monitor entrance doors. A visitor at the door can press the Door Box call button (like a door bell). The Door Box then sends chimes to certain extensions. If you receive Door Box chimes, you can just lift the handset to answer them. You can then talk to the visitor at the door.



Door Boxes come in handy at delivery entrances. Your company doesn't have to have someone at the door to monitor the entrance. You can just answer the Door Box instead. If the door has an electric strike, you can even use your telephone to release the door.

To call a Door Box:

1.  +    + Door Box number (1-8).

To answer a Door Box chime:

1. 

To activate the Door Box strike:

1. While talking to the Door Box, press .

# DSS Console

If you do a lot of call processing (like an operator or dispatcher), you may have either a 110-Button or 24-Button Direct Station Selection (DSS) Console. The DSS Console gives you a Busy Lamp Field (BLF) and one-button access to extensions, trunks and certain system features. Use the DSS Console to help you:

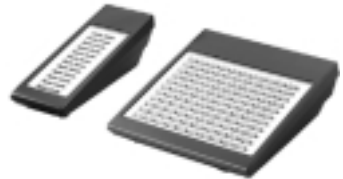

- Call Extensions and Door Boxes
- Place, answer and Transfer outside calls
- Make Internal or External Pages
- Switch the Night Service mode
- Activate DSS Console Alternate Answer (i.e., redirect your calls to another DSS Console)

Your DSS Console may also have keys stored with dialing codes or Programmable Function Key operations. This gives your DSS Console many of the features available on One-Touch and function keys. Check with your Communications Manager to see if your console has these functions.

## To call an extension from your DSS Console:

1. With the 110-button console, press EXT.1 or EXT.2 to select the range.  
*On 28i/124i, EXT.2 selects outside lines.*
2. Press DSS Console key.

*If your call voice-announces, you can make it ring by dialing 1. If you don't have Handsfree, lift the handset to speak.*

<b>Extension BLF</b>	
<b>If DSS key is . . .</b>	<b>Extension is . . .</b>
On	Busy on a call
Off	Idle
Flashing fast	In DND

# DSS Console

---

To place an outside call from your DSS Console:

1. Press DSS Console key assigned to outside line.  
*On 28i/124i, pressing EXT. 2 selects the DSS keys for outside lines.*
2. Dial outside telephone number.  
*If you don't have Handsfree, you must lift the handset to speak.*

<b>Outside Line BLF</b>	
<b>If DSS key is . . . Outside line is . . .</b>	
On	Busy on a call
Off	Idle
Flashing slowly	Ringing

To answer an outside call from your DSS Console:



1. Press flashing DSS Console key assigned to outside line.

To call a Door Box from your DSS Console:

1. Press DOOR + DSS Console key for Door Box you want to call (1-8).  
*If you don't have Handsfree, you must lift the handset to talk to the Door Box.*

<b>Door Box BLF</b>	
<b>If DSS key is . . . Door Box is . . .</b>	
On	Busy or ringing in
Off	Idle

## To Transfer a call using your DSS Console:

1. Place or answer call.  
*If you are on an Intercom call, press  before going to the next step.*
2. Press DSS Console key for extension that will receive Transfer.  
*You cannot Transfer to an extension that is busy or in DND.*
3. (Optional) Announce call.  
*If the called party doesn't want the call, press flashing  to retrieve it.*
4.  to hang up.

## To make a Page using your DSS Console:

1. Press PAGE (for External Paging) or GROUP (for Internal Paging).
2. Press DSS Console Paging key.  
*DSS keys 1-8 are for External Paging zones 1-8. DSS keys 1-64 are for Internal Paging zones 1-64. (If the zone is busy, try again later.)*  
*If you don't have Handsfree, lift the handset to make your announcement.*

<b>Paging BLF</b>	
<b>If DSS key is . . .</b>	<b>Zone is . . .</b>
On	Busy
Off	Idle

# DSS Console

Switching the Night Service mode from your DSS Console:

1. Press Night Service key (NIGHT, DAY, BREAK or NITE 2).

<b>Night Service BLF</b>	
<b>If this key is lit . . .</b>	<b>System in in the . . .</b>
NIGHT	Night Mode
DAY	Day Mode
BREAK	Rest Mode
NITE2	Midnight Mode

To activate DSS Console Alternate Answer:

1. Press ALT.

*You hear a short confirmation tone.  
If you hear a long tone, you cannot enable Alternate Answer. Another user has already enabled your console as their Alternate Answer destination.*

<b>Alternate Answer BLF</b>	
<b>When the ALT key is . . .</b>	<b>Alternate Answer is . . .</b>
On	Enabled
Off	Disabled

Flash allows you to access certain features of the telephone company or PBX to which your phone system is connected. This lets you take full advantage of whatever features the connected telephone company or PBX offers. Flash accesses these features by momentarily interrupting the loop current on your outside line. This is much like briefly pressing and then releasing the hookswitch on your telephone at home.

To flash the outside  
line you are on:

1. 

# Forced Trunk Disconnect

Forced Trunk Disconnect enables you to disconnect (release) another extension's active outside call if you need to use their line. You can then place a call on the released line.



## CAUTION

Forced Trunk Disconnect abruptly terminates the active call on the line. You should use this feature only in an emergency and when no other lines are available.



To disconnect a busy trunk:

1. Press  for the busy trunk.

**OR**

Dial trunk access code (e.g.,  

+ trunk number).

2.  .

*You hear confirmation beeps as the system disconnects the line. You can now place a call on the free line.*





# General Message





 This feature requires a Voice Announce Unit (VAU).

A General Message is a prerecorded Voice Announce Unit (VAU) message to which you and your co-worker's can listen. This message typically contains important company information that all employees should hear.

## To listen to the General Message:

1. Do not lift the handset or press .
2. 

## To record, listen to or erase your General Message:

1.  +   .
2. To record, dial .

**OR**

To listen, dial .

**OR**

To erase, dial .

*If you dial 5 or 7, you can dial # to hear the message again.*

*If you dial 3, you can press HOLD to cancel before going to the next step.*

3.  to hang up.

*MW flashes on each phone until the user listens to the message.*

# Group Call Pickup

If you frequently work together with the same people, your extensions may be in a Call Pickup Group. This allows you and your co-workers to use Group Call Pickup to easily answer each other's ringing calls. Group Call Pickup also helps if you frequently cover for co-workers in another Pickup Group. When a call rings one of their phones, you can intercept it even if you don't know their extension numbers.

With Group Call Pickup, you can intercept the following types of calls:

- A call ringing an extension in your own Pickup Group.
- A call ringing an extension in another Pickup Group when you know the group number.
- A call ringing an extension in another Pickup Group when you don't know the group number.

To answer a call ringing another phone in your Pickup Group:

1.  $\overline{\text{CALL1}} + \overline{\text{FUNCTION}}$  (Pickup).

*OR*

$\overline{\text{CALL1}} + * \overline{\text{ }}$

To answer a call ringing a phone in another Pickup Group:

**When you don't know the Pickup Group Number**

1.  $\overline{\text{CALL1}} + \overline{\text{FUNCTION}}$  (Pickup).

*OR*

$\overline{\text{CALL1}} + \overline{\text{TUV}} \overline{\text{8}} \overline{\text{MNO}} \overline{\text{6}} \overline{\text{WXYZ}} \overline{\text{9}}$

**When you know the Pickup Group number**

1.  $\overline{\text{CALL1}} + \overline{\text{FUNCTION}}$  (Pickup).

*OR*

$\overline{\text{CALL1}} + \overline{\text{TUV}} \overline{\text{8}} \overline{\text{MNO}} \overline{\text{6}} \overline{\text{TUV}} \overline{\text{8}} + \text{Pickup Group number (1-9 or 01-64)}$ .

# Group Listen

Use Group Listen when you want others in your office to listen in on your call. While you talk on the handset, your caller's voice broadcasts over your telephone's speaker. Group Listen automatically turns your Handsfree microphone off so your caller cannot hear the conversation in your office.

## To initiate Group Listen:

1. Place or answer call using the handset.
2.  twice (but do not hang up).

*SPK flashes slowly.*

*You can talk to the caller through your handset. Your co-workers hear your caller's voice over your phone's speaker.*

*When you press SPK once, you turn your Speakerphone on and your handset off. The second press turns on Group Listen.*

## To talk Handsfree after initiating Group Listen:

1.  *You must have a speakerphone for Handsfree operation.*

## To cancel Group Listen (without hanging up your call):

1. Do not hang up + Press flashing . *You can talk to your caller over your handset. Your co-workers can no longer hear your caller's voice.*



# Handsfree and Monitor

When it's inconvenient to hold the handset, you can use the speaker and microphone in your telephone and talk Handsfree instead. Handsfree is great when you don't have a free hand for the phone. (For example, you may want to enter data at a computer terminal while talking to a customer on the phone.)



There are three types of Handsfree operation:

<b>Handsfree</b>	You can place and answer calls by pressing SPK instead of using the handset. <b>You must have a Speakerphone to have Handsfree.</b> Check with your Communications Manager.
<b>Automatic Handsfree</b>	You can press a line or line appearance key without first lifting the handset or pressing SPK. Your Communications Manager may have enabled this option for you.
<b>Monitor</b>	You can place a call without lifting the handset, but you must lift the handset to speak. You always have this option - regardless of the type of phone you have or how your system is set up.

To talk Handsfree:

1.  or  or .
2. Place call.
3. Speak toward phone when called party answers.

To change a handset call into a Handsfree call:

1.  and hang up the handset.
2.  to hang up when you are done.

To change a Handsfree call into a handset call:

1. 

# Headset Operation

To get even more freedom and convenience than with Handsfree, purchase a Headset and connect it to your telephone. In addition to having your hands free for other work, you'll have privacy on a call that is not available with Handsfree.

To enable the headset mode:

1. Unplug the telephone handset and plug in the headset.
2. Press **[FUNCTION]** (Headset).

**OR**

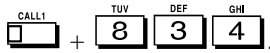

*You hear a confirmation beep. The headset **[FUNCTION]** key lights when you enable the headset mode.*

*You can still receive and respond to voice-announced Intercom calls while in the headset mode.*

While you're in the headset mode:

1. **[LINE]** to make an outside call.

**OR**



**OR**

If on a call,  to hang up.

To disable the headset mode:

1. Unplug the headset and plug in the handset.
2. **[FUNCTION]** (Headset).

**OR**

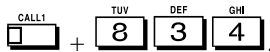

# Hold

Don't place your handset down on the desk when you need your caller to wait, use Hold instead. Hold places your call in a temporary waiting state until you can get back to it. While the call waits, you can process calls or use other features. And don't worry if you forget about the call and leave it on Hold too long - it will recall back to you.



Your telephone system provides four types of Hold (see the chart below). Your Communications Manager can tell you which types you can use.

<b>System Hold</b>	<i>For your normal calls . . .</i> When you place an outside call on System Hold, it flashes your line key and the line keys on your co-worker's phones as well. Either you or another co-worker can pick up the call on Hold.
<b>Exclusive Hold</b>	<i>For high priority calls . . .</i> After you place an outside call on Exclusive Hold, it flashes your line key but looks busy to your co-workers. Only you can pick up the call from Hold.
<b>Group Hold</b>	<i>Put calls on Hold for your Department Group . . .</i> If you are a member of a Department Calling Group, you can use Group Hold. When you place an outside call on Group Hold, only you and the members of your Department Calling Group can pick it up.
<b>Intercom Hold</b>	<i>While talking to a co-worker . . .</i> Intercom calls can also go on Hold. However, the Intercom call on Hold stays on your phone. Another extension user cannot pick it up.

## System Hold

To place an outside call on System Hold:

1. 



The  or  key flashes slowly while on Hold; flashes fast when recalling.

To pick up an outside call on System Hold:

1. Pressing flashing .

## Exclusive Hold

To place an outside call on Exclusive Hold:





1.  (Exclusive Hold).  
*The  key flashes fast while on Hold; flashes slowly when recalling.*

To pick up an outside call on Exclusive Hold:

1. Pressing flashing .

## Group Hold

To place a call on Hold so anyone in your group can pick it up:



1.  +    +  to hang up.

To pick up a call on Group Hold:



1.  +   .

## Intercom Hold

To place an Intercom call on Hold:

1.  +  to hang up.

To pick up an Intercom call from Hold:

1.  + .

# Hotline

When you need one-button calling and Transfer to a co-worker, use Hotline. You'll find Hotline to be a great convenience if there is someone in your company with whom you work closely (such as your business partner). You and your partner can call or Transfer calls to each other just by pressing a single key.

Your Hotline key shows the status of your Partner's extension:

When the key is . . .	Your partner's phone is . . .
Off	Idle
On	Busy or ringing
Fast Flash	In Do Not Disturb

To place a call to your Hotline partner:



1. **[FUNCTION]** (Hotline).  
*Optionally lift the handset.*

To Transfer your outside call to your Hotline partner:

1. **[FUNCTION]** (Hotline) + Announce call and hang up.  
**OR**  
**[FUNCTION]** (Hotline) + Hang up to have your call wait at your Hotline partner unannounced.  
*If unanswered, the call recalls to you.*

To answer a call from your Hotline partner:

1. If you hear two beeps, speak toward the phone.  
**OR**

If your telephone rings,  or .



Call a co-worker over the Intercom. Normally, you are not restricted from placing an Intercom call to any other extension. However, if your telephone system is shared by several businesses, you may not be able to call the other business's extensions. Check with your Communications Manager.

## To place an Intercom call:

1.  + Extension number.  
*You can optionally dial 0 for your operator or \*8 for your Voice Mailbox.*  
*If the extension you call is busy or doesn't answer, you can (without hanging up):*
  - Dial another extension.
  - Dial 8 to leave a message in your co-worker's mailbox.*For one-touch calling, see Hotline (page 58), Call Coverage (page 71) or One-Touch Keys (page 78) instead.*

## To answer an Intercom call:

1. If you hear two beeps, speak toward the phone.  
*Your telephone picks up your voice.*  
**OR**  
If your telephone rings,  .

Intercom calls *you place* may either ring or voice-announce at your co-worker's extension. What happens depends on how your co-worker's extension is set up. You can, however, dial a code to change from one method to the other.

The Intercom calls *you receive* can also either ring or voice-announce. You decide the best way to answer your Intercom calls and then enable the option you want.





# Intercom

To change the mode of an Intercom call you placed:





1. 

*If the call is ringing, this makes it voice-announce. If the call voice-announces, this makes it ring.*

To make your incoming Intercom calls voice-announce:

1.  +    +  to hang up.

To make your incoming Intercom calls ring:

1.  +    +  to hang up.

## Intercom Abandoned Call Display

You can display a list of the Intercom calls placed to you while you were away from your phone.

To display the list of Intercom calls you did not answer:

1.  + .

*Press CALL2 repeatedly until no more calls display.*

2.  to return to the normal Time and Date display.

# Last Number Redial

Instead of dialing a busy or unanswered outside call again, quickly redial it with Last Number Redial. Last Number Redial stores the last outside call you placed in memory so you can easily recall it. The stored number can be up to 24 digits long, using 0-9, # or \*.

You can also quickly redial your last call using Repeat Redial (page 103) and Save Number Dialed (page 107).

To redial your last call:

1. <sup>LINE</sup> + <sup>LND</sup> + <sup>CALL1</sup>.

*If you don't press a line key, the system automatically selects a trunk from the same group as your original call.*

**OR**

- 
- <sup>CALL1</sup>
- +
- 
- <sup>#</sup>
- 
- <sup>JKL</sup>
- 5**
- .

*The system automatically selects a trunk from the same group as your original call.*

To check the stored number:

1. <sup>LND</sup>

*The stored number displays for six seconds. The stored number dials out if you:*

- Lift the handset
- Press an idle line key
- Press an idle CALL key, or
- Press SPK

2. <sup>CLEAR</sup>

To erase the stored number:

1. <sup>CALL1</sup> + <sup>TUV</sup> **8** <sup>PQRS</sup> **7** <sup>MNO</sup> **6**.

# Line Preference

---

Line Preference determines how you place and answer calls. There are two types of Line Preference: Incoming Line Preference and Outgoing Line Preference. Ask your Communications Manager which type you have.

<b>Incoming Line Preference</b>	Incoming Line Preference sets how you answer calls. When a call rings your phone, lifting the handset answers either the ringing call ( <i>Ringing Line Preference</i> ) or seizes an idle line ( <i>Idle Line Preference</i> ). If you primarily answer calls and seldom place calls, Ringing Line Preference is for you. If you normally place calls and seldom answer them, then Idle Line Preference is for you.
<b>Outgoing Line Preference</b>	Outgoing Line Preference sets how you place calls. With <i>Outgoing Intercom Line Preference</i> , you hear Intercom dial tone when you lift the handset. With <i>Outgoing Trunk Line Preference</i> , you get dial tone on an outside line when you lift the handset. If you normally call co-workers, use Outgoing Intercom Line Preference. If you frequently call outside your company, use Outgoing Trunk Line Preference.  If you have Incoming Idle Line Preference, Outgoing Line Preference also determines how your phone works as a call rings.







# Meet Me Conference

Use Meet Me Conference to have a telephone meeting which lets others join if they choose. After you announce the Meet Me Conference over the Paging, a co-worker joins the meeting by dialing the Meet Me Conference code. There are two types of Meet Me Conference: Meet Me External Conference and Meet Me Internal Conference. With Meet Me External Conference, announce the meeting with External Paging. With Meet Me Internal Conference, announce the meeting with Internal Paging. The system allows either four or eight parties maximum per Meet Me Conference.

In addition to Meet Me Conference, there are other ways to have a telephone meeting. See Conference (page 33), Voice Call Conference (page 34), Meet Me Paging (page 65) and Tandem Trunking (page 115).

## Meet Me External Conference

To make a Meet Me External Conference:

1. While on a call, press .
2.    + External Paging zone (1-8 or 0 for All Call).  
**OR**  
 (External Paging).  
*You can optionally press CALL1 and dial combined zones \*10 to \*18 instead. See Paging on page 90 for more on combined zones.*
3. Announce the zone.
4.  twice when co-worker answers your page.
5. Repeat steps 1-4 for each co-worker you want to add.

# Meet Me Conference

To join a Meet Me External Conference:

1.  $\overset{\text{CALL1}}{\boxed{\phantom{000}}} + \overset{\text{TUV}}{\boxed{8}} \overset{\text{MNO}}{\boxed{6}} \overset{\text{JKL}}{\boxed{5}} + \text{External Paging zone (1-8 or 0 for All Call).}$   
*You connect to the other parties.*

## Meet Me Internal Conference

To make a Meet Me Internal Conference:

1. While on a call,  $\overset{\text{CONF}}{\boxed{\phantom{000}}}$ .
2.  $\overset{\text{TUV}}{\boxed{8}} \overset{\text{OPER}}{\boxed{0}} \boxed{1} + \text{Internal Paging zone (0-9 or 00-64).}$

**OR**

**FUNCTION** (Internal Paging).

*You can optionally press CALL1 and dial combined zones \*10 to \*18 instead. See Paging on page 90 for more on combined zones.*

3. Announce the call.
4.  $\overset{\text{CONF}}{\boxed{\phantom{000}}}$  twice when co-worker answers your page.
5. Repeat steps 1-4 for each co-worker you want to add.

To join a Meet Me Internal Conference:

1.  $\overset{\text{CALL1}}{\boxed{\phantom{000}}} + \overset{\text{TUV}}{\boxed{8}} \overset{\text{MNO}}{\boxed{6}} \overset{\text{DEF}}{\boxed{3}}$  (if your phone is in the zone called).

**OR**

$\overset{\text{CALL1}}{\boxed{\phantom{000}}} + \overset{\text{TUV}}{\boxed{8}} \overset{\text{MNO}}{\boxed{6}} \overset{\text{GHI}}{\boxed{4}} + \text{Zone (0-9 or 00-64) (if your phone is not in the zone called).}$

**OR**

**FUNCTION** (Internal Paging Zone Answer) (if your phone is in the zone called).





# Meet Me Paging

Need to talk to a co-worker and don't know where they are? Meet Me Paging allows you to set up a private meeting on a Page zone. While you meet on the zone, no one else can hear your conversation, join in or make an announcement using that zone. There are two types of Meet Me Paging: Meet Me External Paging and Meet Me Internal Paging. With Meet Me External Paging, you hold the meeting on an External Paging zone. With Meet Me Internal Paging, you hold the meeting on an Internal Paging zone.

In addition to Meet Me Paging, there are other ways to have a telephone meeting. See Conference (page 33), Voice Call Conference (page 34), Meet Me Conference (page 63) and Tandem Trunking (page 115).

## Meet Me External Paging

To make a Meet Me External Page:

1.  +    + External Paging zone (1-8 or 0 for All Call).





**OR**

 (External Paging Zone).

2. Announce the zone.

*You can optionally press CALL1 and dial combined zones \*10 to \*18 instead. See Paging on page 90 for more on combined zones.*

To join a Meet Me External Page:





1.  +    + External Paging zone (1-8 or 0 for All Call).

*You connect to the other party.*

# Meet Me Paging

## Meet Me Internal Paging

To make a Meet Me Internal Page:

1.  +    + Internal Paging zone (0-9 or 00-64).





**OR**

 (Internal Paging Zone).

*You can optionally press CALL1 and dial combined zones \*10 to \*18 instead. See Paging on page 90 for more on combined zones.*

2. Announce the zone.





To join a Meet Me Internal Page:

1.  +    (if your phone is in the zone called).

**OR**

 (Internal Paging Zone Answer) (if your phone is in the zone called).

**OR**



-  +    (if your phone is not in the zone called).





# Memo Dial

While on an outside call, use Memo Dial to jot a number down in your phone's memory. Memo Dial is like a notepad. For example, if you dial Directory Assistance and ask for a number, you can use Memo Dial to remember it. You can then quickly call the stored Memo Dial number after you hang up.

To store a number while on a call:

1.  (Memo Dial) + Dial number you want to store +  (Memo Dial).  
*Continue with conversation.*
2.  to hang up when you are done.

To call a stored Memo Dial number:

1. Do not lift the handset +  (Memo Dial).
2.   
*The stored number dials out only if you store a trunk access code before the number.*

**OR**





*The stored number dials out.*



To check the stored Memo Dial number:

1. Do not lift the handset +  (Memo Dial).  
*The stored number displays.*

To erase the stored Memo Dial number:

1.  +  (Memo Dial).
2.  to hang up when you are done.

# Message Waiting



Don't keep recalling a busy or unanswered co-worker. Leave them a Message Waiting request for a return call instead. The request is a flashing  <sup>MW</sup> lamp at the extension you call and a steadily lit  <sup>MW</sup> lamp on your phone. When your co-worker answers the Message Waiting, they automatically call your extension. And if someone leaves you a Message Waiting, you'll know you didn't miss their call.

In addition, Message Waiting lets you:

- View and selectively answer messages left at your display extension.
- Cancel messages left at your extension.
- Cancel messages you left at other extensions.



You can leave messages at any number of extensions simultaneously. Also, any number of co-workers can leave you a message at the same time.

## To leave a Message Waiting:

1. Call busy or unanswered extension.
2.  or  (Message Waiting).
3.  to hang up.  
*Your MW lights.*

## To answer a Message Waiting:

*When you have a Message Waiting, MW flashes fast.*

1.  +  .

**OR**







-  +  (Message Waiting).

*If the called extension doesn't answer, dial 0 or press  (Message Waiting) to leave them a message.*

# Message Waiting

## To display/check your Messages Waiting list:





*These are the messages co-workers left at your extension. The messages left first display first.*

1.  +   +   or   to scroll through your messages.

*Press your Message Waiting key or CALL1 to call the displayed extension.*

2.  to return to the Time and Date display.





**OR**

1.  (Message Waiting).
2.   or   to scroll through your messages.





*Press your Message Waiting key or CALL1 to call the displayed extension.*

## To cancel all your Messages Waiting:

*This includes messages you have left for other extensions and messages other extensions left for you.*

1.  +   .
2.  to hang up.

## To cancel messages you left at an extension:

1.  +    + Extension.
2.  to hang up.

# Microphone Cutoff

Turn your telephone's Handsfree and handset microphone off when you don't want your caller to hear your voice. When you turn your Handsfree or handset microphone off, it stays off until you choose to turn it back on.

To turn your Handsfree microphone off and on:



*This turns your Handsfree microphone off. You can press this key anytime while your phone is idle, busy on a call or ringing.*

**OR**



*This turns your Handsfree microphone back on.*

To turn your Handsfree and handset microphone off and on:

1.  (Microphone Cutoff).

*You hear confirmation beeps. Your mic is off when the key is lit.*

*You can press this key anytime while on an outside call. For Intercom calls, you can only press this key when the co-worker you call lifts the handset or*

*presses  to answer.*

# Multiple Directory Numbers/Call Coverage

## Multiple Directory Numbers

Multiple Directory Numbers allow you to have more than one extension number. In addition to your "normal" extension number (e.g., 320), you can have additional "virtual" extension numbers on Multiple Directory Number function keys. For example, you can have virtual extension number 600 for your sales calls. When a call routes to 600, it goes to your Multiple Directory Number key assigned to virtual extension 600. In this way, you can easily tell calls to your extension from sales-specific calls. Check with your Communications Manager to see if you have any Multiple Directory Number keys.

## Call Coverage

Use a Multiple Directory Number key assigned to a co-worker's extension when you need Call Coverage for their calls. The Multiple Directory Number key shows you when your co-worker is busy and flashes slowly when they have an incoming call. You can even press the key to intercept the incoming call.

You can have Multiple Directory Number keys for many different extensions and virtual extensions. In addition, you and other co-workers can share the same Multiple Directory Number keys. For example, everyone in your department could have a key for the sales virtual extension. Your Multiple Directory Number keys can ring or not ring. Your Communications Manager can tell you how your keys are set up.

To answer a call ringing your Multiple Directory Number/Call Coverage key:

1. Press flashing **[FUNCTION]** (Multiple Directory Number).

To place a call to a Multiple Directory Number:

1.  **[FUNCTION]**
2. **[FUNCTION]** (Multiple Directory Number).

**OR**

Dial virtual extension number.

# Name Storing

---

You can program a name for your extension. The name can be up to 10 digits long. When you call a co-worker that has a display telephone, they see your name instead of your extension number. Your co-worker knows who's calling without having to look up your extension number.







Use the following chart when entering or editing your name. When using the One-Touch (DSS) keys, press the key once for the first character, twice for the second character, etc. For example, to enter a C, press DSS1 three times.

<b>Keys for Entering Names</b>	
<b>Use this key . . .</b>	<b>When you want to . . .</b>
DSS1	Enter characters A-D. After selecting your entry, press CHECK to have the system accept it.
DSS2	Enter characters E-H. After selecting your entry, press CHECK to have the system accept it.
DSS3	Enter characters I-L. After selecting your entry, press CHECK to have the system accept it.
DSS4	Enter characters M-P. After selecting your entry, press CHECK to have the system accept it.
DSS5	Enter characters Q-T. After selecting your entry, press CHECK to have the system accept it.
DSS6	Enter characters U-Z. After selecting your entry, press CHECK to have the system accept it.
DSS7	Enter a hyphen (-). After selecting your entry, press CHECK to have the system accept it.

# Name Storing

Keys for Entering Names	
Use this key . . .	When you want to . . .
DSS8	Enter a blank space. After selecting your entry, press CHECK to have the system accept it.
DSS9	Enter extended ASCII characters. Press repeatedly to scroll through the list. After selecting your entry, press CHECK to have the system accept it.
DSS10	Enter punctuation marks. Press repeatedly to scroll through the list. After selecting your entry, press CHECK to have the system accept it.
CHECK	Save text entry as part of the name when you want to select it. You need to press CHECK after selecting characters from One-Touch Keys 1-10. You don't need to press CHECK after dialing a dial pad digit (0-9, # and *).
CLEAR	Clear the text entry if you want to start over.
Dialpad digits 0-9, # and *.	Enter number, # and * as part of the name. You don't need to press CHECK after entering these characters.

To program your extension's name:

1.  +    + Extension # + Enter name (see the chart above).  
*Your name can be up to 10 digits long.*
2. .
3.  to hang up.

# Night Service

---

You may be able to activate Night Service for your system. Used after normal working hours, Night Service redirects your system's incoming calls to where they should ring at night. For example, when most of your co-workers have left for home, your system may redirect calls to the security desk. When you activate Night Service, select one of eight modes of operation:

- Day Mode - normal working hours.
- Night Mode - after hours (usually evening).
- Midnight Mode - late at night to early in the morning.
- Rest Mode - lunch and early evening (dinner time).
- Day Mode 2 - normal working hours.
- Night Mode 2 - after hours (usually evening).
- Midnight Mode 2 - late at night to early in the morning.
- Rest Mode 2 - lunch and early evening (dinner time).





There are two types of Night Service ringing for outside calls: Assigned Night Answer (ANA) and Universal Night Answer (UNA). With ANA, specific telephones are programmed to ring at night (like the security desk in the example above). UNA causes incoming calls to ring over the External Paging speakers. If your extension has a line key for the call, just press the line key to pick up the UNA call. In addition, you may be able to dial the Universal Answer Code to pick up calls for which you don't have line keys.

Your system may switch Night Service modes automatically. Check with your Communications Manager if this happens, and when the switch-over occurs.



# Night Service



To activate Night Service by dialing codes:

1.  +    + Night Service Password.  
*The Night Service Password is normally 0000. Check with your Communications Manager.*
2. Dial the Night Service Mode: 0= Day Mode, 1 = Night Mode, 2 = Midnight Mode, 3 = Rest Mode, 4= Day 2 Mode, 5 = Night 2 Mode, 6 = Midnight 2 Mode, 7 = Rest 2 Mode  
*You hear confirmation beeps.*
3.  to hang up.

To activate Night Service using programmable keys:

1.  (Night Service).  
*You hear a beep and the key lights to indicate the mode selected:*  
*Day Mode Key*  
*Night Mode Key*  
*Midnight Mode Key*  
*Rest Mode Key*  
*Day 2 Mode Key*  
*Night 2 Mode Key*  
*Midnight 2 Mode Key*  
*Rest 2 Mode Key*

To use Universal Answer to pick up a UNA call:

1.  +  .  
*You are connected to the call.*

# Off Hook Signaling

---

Trying to get in touch with a co-worker who is busy on a handset call? Use Off Hook Signaling to let your co-worker know you're trying to get through. The off hook signal you send to your co-worker is either ringing or a voice announcement over their idle (second) line appearance.

Your phone system provides four Off Hook Signaling options (see the chart below). Ask your Communications Manager which options you have.

<b>Automatic Signaling</b>	Calling a busy extension automatically initiates Off Hook Signaling. You'll find this option helpful if you are someone that must quickly process calls (such as a receptionist or operator).
<b>Manual Signaling</b>	After reaching a busy extension, manual signaling gives you the choice of using Off Hook Signaling or activating another feature. If you don't have Automatic Signaling, you have Manual Signaling.
<b>Selectable Off Hook Signaling Mode</b>	If your extension has Handsfree, you can have Off Hook Signaling ring your phone's second channel or voice announce - at your discretion. There are four types of Off Hook Signaling rings you can receive (ask your Communications Manager): <ul style="list-style-type: none"><li>- Muted off hook ringing</li><li>- Normal off hook ringing</li><li>- Two beeps over the speaker</li><li>- One beep in the handset</li></ul>
<b>Called Extension Block</b>	You extension may block Off Hook Signaling from other extensions. Use this option if you don't like to be interrupted while on a call.

## *If the extension you call has Handsfree . . .*

When your off hook signal voice-announces, your co-worker can

# Off Hook Signaling

respond by just speaking toward their phone. Their telephone's Handsfree microphone picks up their voice. Your co-worker's initial call continues uninterrupted.

## *If the extension you call does not have Handsfree . . .*

Your co-worker receives Off Hook Signaling ring. They must first place their initial call on Hold before they can respond to you. They cannot just speak toward their phone.

You can use other options when you are trying to get through. Use Call Waiting (page 25) to wait in line without hanging up. Or, you can leave a Callback request for a return call (page 26). If you want, send your coworker a Message Waiting indication (page 68) or a Voice Mail message (page 125). You may also be able to Voice Over (page 129) to your busy co-worker while they stay on their initial call.

To send Off Hook Signals to an extension busy on a handset call:

1. <sup>PQRS</sup>

**OR**

(Off Hook Signaling).

*If you hear ringback tone, dial 1 to have your call voice-announce (and visa-versa).*

To have Off Hook Signals ring your extension:

1.  + <sup>TUV</sup> <sup>WXYZ</sup> <sup>DEF</sup>.

*To answer an Off Hook Signal at your extension, you must first hang up your current call or place it on Hold.*

To have Off Hook Signals voice-announce at your extension:

1.  + <sup>TUV</sup> <sup>WXYZ</sup> <sup>ABC</sup>.

*If your extension has Handsfree, you can answer an Off Hook Signal by just speaking toward your phone.*

# One-Touch Calling









Use your One-Touch Keys for one button access to co-workers, outside lines and selected system features. You'll find this a great time saver when calling the clients and co-workers you talk to most often. Instead of dialing the codes, just press the One-Touch Key.

Your One-Touch Keys give you:

- **Direct Station Selection** - One button access to your co-worker's extensions.
- **Personal Speed Dial (Outside Calling)** - One button access to outside lines, line groups and telephone numbers. (You can also have Personal Speed Dial if your phone doesn't have One-Touch Keys - see page 81).
- **Abbreviated Dialing** - One button access to Common and Group Abbreviated Dialing bins.
- **Feature Codes** - One button access to Feature Codes (e.g., 2 for Callback).
- **Chain Dialing** - Linking two or more One-Touch Keys for lengthy dialing scenarios.

















One-Touch Calling is the first level of operation on the One-Touch Keys. In other words, One-Touch Calling occurs when you just press the One-Touch Key. There is a second level of One-Touch Key functions called One-Touch Serial Operation (page 82). You access these functions by first pressing the One-Touch Serial Operations key.

To program a One-Touch Key for DSS (extension) calling:















1.  +    +  you want to program.
2. Dial extension number you want assigned to that key + .
3. **Optional for Display Phones:** Enter a name for the One-Touch key (see Name Storing on page 72) + .
3.  to hang up.

# One-Touch Calling

To program a One-Touch Key for outside calling (Personal Speed Dial):







1.  +    +  you want to program.
2.   for Trunk Group Access code.  
**OR**  
   + trunk number (01-192) for a specific trunk.  
**OR**  
   + Trunk Group number (e.g., 1) for a Trunk Group.
3. Dial the number you want to call + .  
*To enter a pause, press .*
4. **Optional for Display Phones:** Enter a name for the One-Touch key (see Name Storing on page 72) + .
5.  to hang up.

To program a One-Touch Key for Abbreviated Dialing:

1.  +    +  you want to program.
2.    for Common or    for Group Abbreviated Dialing.
3. Dial Abbreviated Dialing storage code (e.g., 001) + .
4. **Optional for Display Phones:** Enter a name for the One-Touch key (see Name Storing on page 72) + .
5.  to hang up.

# One-Touch Calling



To assign a Feature Code to a One-Touch Key:

1.  +    +  you want to program.
2. Dial Feature Code you want to store.  
*For example, store 2 to make a call-back key. Refer to the features in this handbook for the appropriate Service Codes.*
3.  to hang up.





To use a One-Touch Key:

1. .  
*If you press a line key before pressing a One-Touch Key for outside calling, the system automatically removes any stored trunk codes.*

To chain the functions of two One-Touch Keys:

1. .  
*Let the stored number dial out.*
2. Press another .  
*The stored digits dial out.*





To check the function of a One-Touch Key:

1.  + .  
*The stored function displays. Repeat this step to check additional keys. If you cannot see the entire number stored, dial .*
2. .



# One-Touch Calling

## Using Personal Speed Dial without One-Touch Keys

To program a Personal Speed Dial number if your phone doesn't have One-Touch Keys:

1.  +   .
2. Dial a Personal Speed Dial bin number (1-9 or 0).  
*Bins 1-9 correspond to One-Touch Keys 1-9. Bin 0 corresponds to key 10.*
3. Dial outside number you want to call.  
*The bin should contain a trunk access code: 9, #9 + Trunk number or 804 + Trunk Group number. To enter a pause, press MIC.*
4.  to hang up.

To dial a Personal Speed Dial number if your phone doesn't have One-Touch Keys:

1.  +  .
2. Dial a Personal Speed Dial bin number (1-9 or 0).  
*The stored number dials out.*





# One-Touch Serial Operation

Do you frequently dial a long sequence of codes and numbers for the same operation? One-Touch Serial Operation can simplify your phone by letting you store the entire sequence of steps under a One-Touch Key. This includes dial pad digits, feature keys, function keys and even other One-Touch Keys. For example, before you leave the office at night you can have One-Touch Serial Operation:

















- Place the system in the Night Mode.
- Call Forward your phone to Voice Mail.
- Ring your home to let them know you are coming.

One-Touch Serial Operation is the second level of operation for One-Touch Keys. You must press the Serial Operations function key before the One-Touch Key. The first level of operation is One-Touch Calling (page 78). This occurs when you just press the One-Touch Key.

To store a series of operations in a One-Touch Key:

1.  +    +  key you want to program.
2. Enter the sequence of operations you want to store (up to 24 entries).

*You can store the following operations:*

Feature Codes		
0-9, # and *		
		
		
		
		

(for pause)



# One-Touch Serial Operation

To store a series of operations in a One-Touch Key:

*If you store a One-Touch Key as part of a Serial Operation, the system stores the first level (One-Touch) function.*



3.  (Serial Operations).

4.  to hang up.

To dial using One-Touch Serial Operation:

1.  (Serial Operation) + .

To check the stored Serial Operation:





1.  +  (twice).

*The stored Serial Operation displays. To check another key, press it twice before going to step 2.*

*If the stored number does not fit in the display, dial \* to see the entire number.*

2. .

To clear a One-Touch Serial Operation:

1.  +    +  you want to clear.

2.  (Serial Operations).

3.  to hang up.







# Outside Calls, Answering

---

There are many types of outside calls that you can answer from your phone. You can tell a lot about the call coming in by listening for ringing, watching your phone's keys and checking the display (if you have one). Also use the chart below as a guide. Ask your Communications Manager about the different types of calls you are expected to answer.



You may have line and loop keys on your phone. A line key is dedicated to a particular outside line. When you press the line key to answer a call, you always get the same line. A loop key works just like a line key, except that it is for any line in a preset line group. When you press a loop key to answer a call, you get whichever line in the group happens to be ringing.

---

<b>For this type of call...</b>	<b>You hear...</b>	<b>And see...</b>
<b>Outside Call that rings your phone</b> (If you have a line key for it)	Two quick rings - repeated	 flashing slowly (red)  flashing slowly
<b>Direct Inward Line<sup>1</sup></b> (If you have a line key for it)	Two quick rings - repeated	 flashing slowly (green)  flashing slowly
<b>Outside call or DIL that rings your phone</b> (If you don't have a line key for it)	Two quick rings - repeated	 flashing slowly
<b>Outside call that just flashes a line key without ringing</b>	No Ringing	 flashing slowly (red)

---

# Outside Calls, Answering



For this type of call...	You hear...	And see...
<b>Transferred Call</b> (If you have a line key for it)	Two quick rings - repeated	 flashing slowly (green)  flashing fast
<b>Transferred Call</b> (If you don't have a line key for it)	Two quick rings - repeated	 flashing fast

<sup>1</sup>These calls initially ring only at your phone.

To answer an outside call:

1.  or .

*Depending on how your phone is set up, you may answer the call automatically. Your phone's Line Preference (page 62) determines what happens when you lift the handset or press SPK to answer a call.*

2. Press flashing  or .

*You may be able to dial #0 at night to pick up calls not ringing your phone.*

# Outside Calls, Placing

Your phone offers you several ways to place outside calls. You can:



- **Press a line key** for one-button access to a specific line.
- **Press a loop key** for one-button access to the first available line in a line group.
- **Dial a code** to select a specific line.
- **Dial a code** to select the first available line in a line group.
- **Dial 9** to use Trunk Group Routing or Automatic Route Selection (ARS).

The method you use depends on how your system and your phone are set up. For example, if you should use only ARS for outgoing calls, don't press line keys or dial up lines and line groups. On the other hand, if your office is set up like a "key system", you and your co-workers will have line keys for the same outside lines. Your Communications Manager can tell you which methods you should use for placing outside calls.





To place an outside call using a line key:

1. .  
*You may have to press SPK or lift the handset before pressing the line key. The line key lights (green).*
2. Listen for dial tone.
3. Dial number.

To dial a code to select a specific line:

1.  +   + Line number (01-192).
2. Dial number.  
*Check with your Communications Manager to see which lines you can use.*

To dial a code to select a line group:

1.  +    + Line group number.



# Outside Calls, Placing

To dial a code to a select line group (Cont'd)

Your line group numbers are 1-9, 01-99 or 001-128. Ask your Communications Manager.

2. Dial number.

To use Trunk Group Routing or ARS:

1.  + .

The system automatically routes your call using ARS or Trunk Group Routing - whichever is installed.

## Converting from Pulse to Tone Dialing

If your company is in a Dial Pulse area, you may need to change the dialing mode of your phone to tone (DTMF) after you place your initial call. This allows you to use dial-up services like electronic banking or a client's Voice Mail.

To change your dialing mode to DTMF:

1. Place outside call normally.  
*Your call dials out as Dial Pulse.*

2. .

The next digits you dial go out as DTMF.

Instead of dialing #, the system may automatically convert to DTMF 10 seconds after you dial the last digit of your outside call.

## Are You Behind a PBX?

Your telephone system may be connected to a Private Branch Exchange (PBX) rather than to the telephone company's lines. This means that when you get dial tone on an outside line, you are really getting dial tone from the PBX. This may affect the way you place outside calls. For example:

- After you press a line key, you may have to dial an additional access code (e.g., 9) before you can dial your outside number.

# Outside Calls, Placing

---

- The PBX may restrict you from placing certain types of calls.
- If you use Automatic Route Selection, your telephone system may automatically insert whatever codes the PBX requires. For example, when you dial 9 926 5400 for an outside call, your system may send 9 9 926 5400 to the PBX.
- You may be able to Transfer to and Conference with other systems connected to the same PBX.

Ask your Communication's Manager if you are behind a PBX.

## You May Have a Private Line

A Private Line is simply a line on your phone that nobody else in the system can use. Only you can place and answer calls on your Private Line. Your Communications Manager can tell you if you have a Private Line.

## If You Hear a Warning Tone

While on an outside call, you may hear occasional beeps through your speaker or handset. These tones remind you that you have been on the call a long time.

## How Prime Line Works

If you have Prime Line, you can place or answer a call on a specific line just by lifting the handset. With *Outgoing Prime Line Preference*, you get dial tone on your Prime Line when you lift the handset. This happens even if another call is ringing in. If you usually need to place calls, *Outgoing Prime Line Preference* may help you.

With *Incoming Prime Line Preference*, lifting the handset answers a ringing call. If you want easy answering of incoming calls, *Incoming Prime Line Preference* may be for you.

If Prime Line sounds helpful to you, your Communications Manager may be able to set it up.





# Outside Calls, Placing

## Did Your Call Go Through?

If you dial certain calls and you find that they do not go through, ask your Communications Manager the following questions:



- Is my telephone Toll Restricted? If it is, what numbers am I prevented from dialing?
- Can I override Toll Restriction? If so, what is my override code?

If you need to override Toll Restriction:

1.  +    + Password.
2.  + Dial number without restriction.

- Do I need to enter Account Codes (page 14) for outside calls?
- Does my telephone use Automatic Route Selection? If it does, are there any numbers that I cannot dial?
- If my phone uses Automatic Route Selection, will I ever be requested to enter an Authorization Code before the call can go through? If so, what are my Authorization Codes?

If you need to enter an ARS Authorization Code:

1.  +  .  
*You hear ARS dial tone.*
2. Dial the outside telephone number.  
*You hear a second ARS dial tone.*
3. Enter the ARS Authorization Code.  
*Ask your Communications Manager for your ARS Authorization Codes.*

# Paging

## Internal Paging

Need to locate a co-worker or make an announcement? Use Internal Paging. Your system can have All Call Internal Paging and, depending on your system, up to 64 zones of Internal Paging. When you make an All Call Paging announcement, your voice broadcasts to all extensions set to receive All Call Paging. When you make a Zone Paging announcement, your voice broadcasts to all the idle extensions in the zone you called.

To make an Internal Page:

1. **FUNCTION** (Internal Paging).

**OR**

**CALL1** + **TUV** **8** **OPER** **0** **1** + Zone.

*Internal Paging zones are 0-9 or 00-64 (0 and 00 are All Call Internal Paging).*

2. Make announcement + **SPK**  to hang up.

## External Paging

If you have your own external speaker system installed, you may be able to use it for External Paging. This is particularly helpful in large or noisy areas where the Internal Paging speakers in the telephones are not loud enough. Your system can have All Call External Paging and up to 8 zones of External Zone Paging.

To make an External Page:

1. **FUNCTION** (External Paging).

**OR**

**CALL1** + **TUV** **8** **OPER** **0** **DEF** **3** + Zone.

*External Paging zones are 0-8, where 0 is All Call External Paging.*



2. Make announcement + **SPK**  to hang up.



## Combined Paging

Use Combined Paging when you want to simultaneously Page into an internal and corresponding external zone. For example, you can Page your company's warehouse and outside loading dock at the same time. Combined Paging is available for Paging zones 1-8 and All Call.

To make a Combined Page:

1.  +   + Combined Paging zone.

*OR*

 (All Call External Page).

*Combined Paging zones are 1-8 (for internal/external zones 1-8) or 0 (for internal/external All Call).*

2. Make Announcement.

3.  to hang up.

# Park

Have a call for a co-worker and can't find them? Put their call in a waiting state called Park so they can pick it up. After you Park the call, Page the co-worker you want to receive the call and hang up. When your co-worker hears the Page, they dial the orbit or press a Park key to pick up the call.

There are two types of Park: System and Personal. Use System Park when you want to have the call wait in a system orbit. (There can be up to 64 system orbits, depending on your system) Personal Park allows you to Park a call at your extension so a co-worker can pick it up.

## To Park a call in a system orbit:

1. Do not hang up.
2.  (Park).

**OR**

 +   + Park Orbit.

*Park Orbits are 1-64. If you hear busy, the orbit is busy. Try another orbit.*

3. Page your co-worker to pick up the call.

4.  to hang up.

*If not picked up, the call will recall to you.*

## To pick up a parked call from a system orbit:





*You can only pick up a call parked by a member of your own Park group.*

1.  +  (Park).

**OR**

 +   + Park Orbit.





## To Park a call at your extension:

1. Do not hang up.
2.  +   .
3. Page your co-worker to pick up the call.
4.  to hang up.

*If not picked up, the call will recall to you.*

## To pick up a call parked at an extension (yours or a co-worker's):

### **If parked at your extension:**

1.  +   .

*OR*

### **If parked at a co-worker's extension:**

1.  +   + Co-worker's extension.

# Park and Page (VAU)

☞ This feature requires a Voice Announce Unit (VAU).

When you are away from your phone, Park and Page can let you know when you have a call waiting to be answered. To enable Park and Page, you record a Personal Greeting along with an additional Paging announcement. Your callers hear your Personal Greeting and automatically wait at your phone. The system then broadcasts your prerecorded Paging announcement. You can go to any co-worker's phone and pick up your waiting call.

For example, you could record a Personal Greeting that says, "*Hello. I am away from my phone right now but please hold on while I am automatically paged.*" Your Paging announcement could say, "*(your name), you have a call waiting on your line.*" Your caller hears your Personal Greeting - and you hear the Paging broadcast.



To have the system  
Page you when you  
have a call:

1.  +  .  
**OR**

1.  (Call Forward to Device).

2.  + When you hear, "*Please start recording*", record your Personal Greeting.



*If you already have Park and Page or Personal Greeting set up, you can dial:*  
*7 to re-record*  
*5 to listen (then # to listen again)*  
*3 to erase (then optionally HOLD to cancel the erase)*

3.  .

4. When you hear, "*Please start recording*", record your Page.

# Park and Page (VAU)







To have the system Page you when you have a call (Cont'd):

5.  + Dial Page Zone that should broadcast your announcement.  
*For example, for Internal Zone 1 dial 801 + 1. Or, for Combined Paging Zone 1, dial \*1 + 1.*
6. Dial Park and Page type:  
2 = All calls  
3 = Outside calls only
7.  to hang up when you are done.  
*Your DND or Call Forwarding (Device) Programmable Function Key flashes when Call Forwarding is activated.*

To pickup up your Park and Page:

1.  +   + Co-worker's extension.

To cancel your Park and Page:

1.  +    +  .
2.  to hang up when you are done.

# Personal Greeting

☞ Personal Greeting requires a Voice Announce Unit (VAU).

Use Personal Greeting to forward your calls and automatically play a recorded message to your callers. This lets you add a personal touch to your Call Forwards. For example, you can record, "*Hi, this is (your name). I'll be out of the office today. In my absence, Mary Jones can answer all your questions. Please hold on for Mary.*" Your callers hear this message and then are forwarded to Mary Jones' phone.

To activate Personal Greeting for your phone:

1.  +   .

**OR**

1.  (Call Forward to Device).

2.   + When you hear, "*Please start recording,*" record your Personal Greeting.

*If you already have Personal Greeting or Park and Page set up, you can dial:*

*7 to re-record*

*5 to listen (then # to listen again)*

*3 to erase (then optionally HOLD to cancel the erase)*

3.  + Personal Greeting condition:

2 = Busy or not answered

4 = Immediate

6 = Not answered

3 = Cancel

4. Dial the destination to receive your calls.

The destination can be:

- A co-worker's extension.
- Your Voice Mailbox (by dialing the Voice Mail master number).

# Personal Greeting

## To activate Personal Greeting for your phone (Cont'd):

- Off-premise via Common Abbreviated Dialing (by entering #2 + bin).
- Greeting without forwarding so caller hears busy (by entering your extension number).

*You cannot forward to a Department Group pilot number.*

### 5. Dial Personal Greeting type:

2 = All calls

3 = Outside calls only

4 = Intercom calls only

### 6. to hang up.

*Your DND or Call Forwarding (Device) Programmable Function Key flashes when Call Forwarding is activated.*



## To cancel your Personal Greeting:

1.  +    + .





2.  to hang up when you are done.

# Programmable Function Keys



Customize your phone by storing features or outside lines under your Programmable Function Keys. For example, to return a Message Waiting, just press your Message Waiting function key instead of

dialing  .

To program a function key:

1.  +    +  you want to program.
2. Select key code from chart below.

To check a stored function:

1.  +  you want to check.  
*The programmed function displays.*

Programmable Function Key Codes			
For this feature	Use key code	When you are	Or dial
Abbreviated Dialing	<b>1037</b>	Dialing a stored Common Abbreviated Dialing number	<b>#2 + bin</b>
	<b>1038</b>	Dialing a stored Group Abbreviated Dialing number	<b>#4 + bin</b>
Barge In	<b>1019</b>	Barging In on a co-worker's conversation	-
Call Forwarding	<b>1080</b>	Forwarding your calls (station)	<b>*2</b>
Call Forwarding Off-Premise	<b>1081</b>	Forwarding your calls (device)	<b>*4</b>
Call Forwarding / Do Not Disturb Override	<b>1022</b>	Overriding an extension's Call Forwarding or Do Not Disturb	-
Callback / Camp On / Trunk Queuing	<b>1020</b>	Leaving a Callback request at a busy extension, Camping On to a busy extension, or Queuing for a busy trunk	<b>2</b>



# Programmable Function Keys

<b>Programmable Function Key Codes</b>			
<b>For this feature</b>	<b>Use key code</b>	<b>When you are</b>	<b>Or dial</b>
Central Office Calls	<b>0001-0192</b>	Pressing a line key to place or answer a trunk call (where trunks can range from 0001-0192)	<b>#9</b>
	<b>1078 + Type + Group</b>	Pressing a loop key to place or answer a call. Type = 0 (Incoming), 1 (Outgoing) or 2 (Both ways), Group = 000 (All groups in or ARS out) or 001-128 (Trunk Group)	-
Conference	<b>1016</b>	Setting up a Conference or a Meet Me Conference	<b>#1</b>
Conference, Voice Call	<b>1017</b>	Setting up a Voice Call Conference	-
Data Communications	<b>1029</b>	Placing a data call	-
	<b>1045</b>	Using your PC for Telemarketing Dial	-
Department Step Calling	<b>1021</b>	Step Calling through a Department Group for an idle member	<b>#</b>
Group Call Pickup	<b>1007</b>	Answering a call ringing another phone in your Pickup Group	<b>*#</b>
	<b>1008</b>	Answering a call ringing a phone in another Pickup Group-if you don't know the group number	<b>869</b>
	<b>1009 + Group Number</b>	Answering a call ringing a phone in a specific Pickup Group	<b>868</b>
Hotline	<b>1058 + ext. number</b>	Placing a call to your Hotline partner	-
Headset Operation	<b>1028</b>	Enabling or disabling Headset Operation	<b>834</b>

# Programmable Function Keys

Programmable Function Key Codes			
For this feature	Use key code	When you are	Or dial
Hold	<b>1043</b>	Putting a call on System Hold (if your phone's Hold key is reassigned)	-
	<b>1044</b>	Putting a call on Exclusive Hold	-
Meet Me Conference and Meet Me Paging	<b>1010</b>	Joining a Meet Me Conference or Page	<b>863</b>
Memo Dial	<b>1015</b>	Storing, using or checking a Memo Dial number	-
Message Waiting	<b>1023</b>	Leaving or answering a Message Waiting	<b>0 or *0</b>
Microphone Cutoff	<b>1026</b>	Using Microphone Cutoff	-
Multiple Directory Numbers	<b>1036 + ext.</b>	Placing a call or covering your virtual (phantom) extension / Call Coverage	-
Night Service	<b>1039 + pswd</b>	Activating the Day Mode	<b>818 + pswd (0000) + 0</b>
	<b>1040 + pswd</b>	Activating the Night Mode	<b>818 + pswd (0000) + 1</b>
	<b>1041 + pswd</b>	Activating the Midnight Mode	<b>818 + pswd (0000) + 2</b>
	<b>1042 + pswd</b>	Activating the Rest Mode	<b>818 + pswd (0000) + 3</b>

# Programmable Function Keys

<b>Programmable Function Key Codes</b>			
<b>For this feature</b>	<b>Use key code</b>	<b>When you are</b>	<b>Or dial</b>
Night Service (cont'd)	<b>1090</b> +	Activating the Day 2 Mode	<b>818</b> + <i>pswd</i> <b>(0000)</b> + 4
	<b>1091</b> +	Activating the Night 2 Mode	<b>818</b> + <i>pswd</i> <b>(0000)</b> + 5
	<b>1092</b> +	Activating the Midnight 2 Mode	<b>818</b> + <i>pswd</i> <b>(0000)</b> + 6
	<b>1093</b> +	Activating the Rest 2 Mode	<b>818</b> + <i>pswd</i> <b>(0000)</b> + 7
Off Hook Signaling	<b>1018</b>	Signaling a busy extension	<b>7</b>
One-Touch Serial Operation	<b>1034</b>	Storing, using or clearing a One-Touch Serial Operation	<b>852</b>
Paging, External	<b>1004</b> +	Making an external zone page	<b>803</b> + <i>zone</i>
	<b>1005</b>	Making a Combined All Call page	<b>803</b> + 0
Paging, Internal	<b>1006</b> +	Broadcasting to an Internal Paging Zone	<b>801</b> + <i>zone</i>
	<b>1076</b>	Broadcasting an Internal All Call Page	<b>801</b> + <b>0 or 00</b>
Park	<b>1033</b> +	Placing a call into or retrieving a call from a Park Orbit <b>(1-9 or 01-64)</b>	<b>#6</b> <b>(Park)</b> <b>*6</b> <b>(Pickup)</b>

# Programmable Function Keys

Programmable Function Key Codes			
For this feature	Use key code	When you are	Or dial
Repeat Redial	<b>1075</b>	Activating Repeat Redial	<b>DIAL + LND</b>
Reverse Voice Over	<b>1056 +</b> <i>dest. ext.</i>	Initiating Reverse Voice Over	-
Room Monitor	<b>1025</b>	Activating Room Monitor	-
Save Number Dialed	<b>1014</b>	Saving, redialing or checking a saved number	-
Secretary Call (Buzzer)	<b>1031 +</b> <i>sec. ext.</i>	Calling your secretary (using the buzzer)	-
Secretary Call Pickup	<b>1032 +</b> <i>boss ext.</i>	Activating Secretary Call Pickup	-
Selectable Display Messaging	<b>1081</b>	Forwarding your calls (device)	<b>*4</b>
Serial Call	<b>1035</b>	Placing a Serial Call to a co-worker	-
Transfer	<b>1077</b>	Transferring a call (if CONF[TRF] is not set for Transfer)	-
Trunk Group Routing	<b>1011</b>	Accessing a trunk using Trunk Group Routing	-
Trunk Groups	<b>1012 +</b> <i>group</i>	Accessing a Trunk Group (Groups are 1-9, 01-99 or 001-128)	<b>804</b>
Trunk Queuing	<b>1020</b>	Camping On or Queuing for a trunk	<b>2</b>
VAU Park and Page/Personal Greeting	<b>1081</b>	Forwarding your calls (device)	<b>*4</b>
Voice Mail	<b>1059 +</b> <i>ext.</i>	Calling Voice Mail or leaving a message	<b>*8 or 8</b>
	<b>1060</b>	Using Voice Mail Record	-
Voice Over	<b>1057</b>	Initiating or responding to Voice Over	<b>6</b>

# Repeat Redial



Trying to get in touch with a customer and their phone is always busy or unanswered? Don't keep redialing it manually - have Repeat Redial do it for you. Repeat Redial will retry your call automatically (up to three times) so you can go back to work.

You can also quickly redial your last call using Last Number Redial (page 61) and Save Number Dialed (page 107).

## To use Repeat Redial:

1. Place outside call.

*Listen for busy or no answer.*

2.  + .



**OR**

 (Repeat Redial).

*Your Repeat Redial key flashes while you wait for the system to redial.*



3.  to hang up.

*Your phone periodically redials the call.*

4.  or  when party you call answers.

## To cancel Repeat Redial:

1. Do not lift handset.

2.  + .

**OR**

 (Repeat Redial).

# Reverse Voice Over

While you are busy on a handset call, Reverse Voice Over allows you to make a private Intercom call to an idle co-worker. Just press your Reverse Voice Over function key to call your co-worker. Your initial caller cannot hear your voice, but you can keep talking to your co-worker as long as you hold down your key.

Reverse Voice Over is great, for example, if you're busy on the phone and you need an associate to get you a file. While your caller is talking:

- Press the Reverse Voice Over key.
- Request the file.
- Return to the call without the caller even knowing you were gone.

If you're not busy on the phone, your Reverse Voice Over key works the same as a Hotline key. Just press the key to call the assigned co-worker. The Reverse Voice Over key even shows you the status of your co-worker:

When the key is . . .	Your co-worker's phone is . . .
Off	Idle
Slow Flash	Busy or has a call ringing
Fast Flash	In Do Not Disturb

## When You're On a Call

To place a Reverse Voice Over Call:

1. Press and hold **[FUNCTION]** (Reverse Voice Over).

*Your Reverse Voice Over key lights (green).*

To return to your initial caller:

1. Release **[FUNCTION]** (Reverse Voice Over).

## When Your Phone is Idle

To place a call to your Reverse Voice Over destination:

1. **[FUNCTION]** (Reverse Voice Over).

*You can optionally lift the handset for privacy.*

# Ringdown

Call a co-worker or outside party by just lifting the handset on your telephone. The call goes through automatically - there is no need to dial digits or lift the handset. There are two types of Ringdown: Ringdown Extension and External Hotline. With Ringdown Extension, you reach another extension (typically a lobby or service phone) when you lift the handset. If your phone has External Hotline, your phone automatically dials a specified Common Abbreviated Dialing number instead. If you want either of these Ringdown options on your phone, talk to your Communications Manager.

When a user lifts the handset on a Ringdown Extension, the ringdown occurs after an interval that is set in system programming. Try to monitor this operation. If the interval is too long, unauthorized users may have time to call your co-workers or use system features. (External Hotline always occurs as soon as you lift the handset.)



To use Ringdown:



To bypass Ringdown  
(for Ringdown  
Extension only):

1. Do not lift handset.

2.  + Place Intercom or outside call.  
*OR*

Press  for outside call +   
*OR*

 + Place Intercom call before  
Ringdown goes through.

To answer a call if you  
are a Ringdown  
Destination:

1. Speak toward your phone if the call  
voice-announces.

*OR*  
 if call rings.

# Room Monitor

---

Use Room Monitor when you want to listen to the sounds in another work area. For example, Room Monitor could let you listen to the sounds in the warehouse when it's left unattended. You just set up a Room Monitor with a phone in the warehouse area.

You must activate Room Monitor at your phone and at the phone you want to monitor. You can only monitor one phone at a time. In addition, Room Monitor is for *listening only* (i.e., you cannot talk to the monitored extension).

## To activate Room Monitor (at your own phone):

1. Do not lift handset or press .
2. **FUNCTION** (Room Monitor) + Extension you want to monitor.  
*The Room Monitor key flashes.*

## To activate Room Monitor (at the phone you want to monitor):

1. Do not lift handset or press .
2. **FUNCTION** (Room Monitor) + Your own extension number.  
*The Room Monitor key flashes.*

## To cancel Room Monitor (at either phone):

1. **FUNCTION** (Room Monitor).  
*The Room Monitor key at both phones goes out.*



# Save Number Dialed

While on an outside call, you can save the number you just dialed and easily dial it later. This lets you quickly redial a busy or unanswered number without manually dialing any digits. Your system remembers your saved number until you save a new one in its place.

You can also quickly redial your last call using Last Number Redial (page 61) and Repeat Redial (page 103).

To save the outside number you just dialed:

Use the following procedure before hanging up.

1. **[FUNCTION]** (Save Number Dialed).



*The number you save can be up to 24 digits long, using 0-9, # and \*.*

To redial a Saved Number:

1. **[LINE]** + **[FUNCTION]** (Save Number Dialed).  
*This selects a specific line for the call. The stored number dials out.*

**OR**

1. 

2.   

**OR**

1. **[FUNCTION]** (Save Number Dialed).

*Save Number Dialed selects a line from the same group as your original call. The stored number dials out.*

# Save Number Dialed





---

To see the number you saved:

1.  (Save Number Dialed).  
*The stored number displays for six seconds. The stored number dials out if you:*
  - Lift the handset
  - Press an idle line key
  - Press an idle CALL key
  - Press SPK

2. 

To clear your saved number:

1.  +    +  to hang up.

# Secretary Call

Secretary Call Buzzer lets you alert a co-worker without disturbing their work. They can then call you on the Intercom when it's convenient. To use this feature, both you and your co-worker must have Secretary Call Buzzer keys. When you press your buzzer key, your co-worker gets a beep and their buzzer key starts to flash. Your own buzzer key lights. The buzzer keys continue to indicate until you or your co-worker cancels the feature.

You might want to use this feature, for example, if you need to talk to an associate who is having a meeting in their office. After being alerted, your associate can call you back when they're available.

You can have Secretary Call Buzzer keys for many extensions.

**To buzz your secretary or boss:**

1. Do not lift the handset.
2. **[FUNCTION]** (Secretary Call Buzzer).

*Your boss or secretary hears a splash tone. Your buzzer key lights steadily. Your boss or secretary's buzzer key flashes fast.*

**To check to see who left you a Secretary Call:**

1. Do not lift the handset.
2. **CHECK** + **[FUNCTION]** (Secretary Call Buzzer).
3. **CLEAR**

**To answer your Secretary Call indication:**

1. Place an Intercom call to the extension that called you.  
*This does not automatically clear the Secretary Call indication.*

# Secretary Call

---

To cancel a Secretary Call you left at another extension:

1. Press lit **[FUNCTION]** (Secretary Call Buzzer).  
*Both the boss and secretary buzzer keys go out.*

To cancel a Secretary Call left at your extension:

1. Do not lift your handset.
2. Press flashing **[FUNCTION]** (Secretary Call Buzzer).  
*Both the boss and secretary buzzer keys go out.*

## Secretary Call Pickup

Press your Secretary Call Pickup key to have calls intended for a co-worker go to you instead. This gives you a simplified type of Call Forwarding for an associate with whom you work closely. For example, if you and a co-worker handle all your company's service calls, Secretary Call Pickup lets you easily answer your co-worker's calls if they leave their desk.

You can have Secretary Call Pickup keys for many extensions.

To activate Secretary Call Pickup:

1. **[FUNCTION]** (Secretary Call Pickup).  
*You hear a beep and your key lights.*

To cancel Secretary Call Pickup:

1. Press lit **[FUNCTION]** (Secretary Call Pickup).  
*You hear a beep and your key goes out.*

To check the Secretary Call key assignment:

1. **CHECK** **[ ]** + **[FUNCTION]** (Secretary Call Pickup).
2. **CLEAR** **[ ]**

# Selectable Display Messages



Activate a Selectable Display Message when you leave your desk. A co-worker calling your extension will see the message you activated on their telephone's display. For example, when you leave for lunch, activate the "OUT FOR LUNCH BACK AT" message and enter the time when you will return. Your callers will know where you have gone and when you will be back.

The chart below shows the standard Selectable Display Messages. You'll notice that you can add additional information to messages 1-8 and 10. Your callers will appreciate this information since they will know where to call you or when you will return.

No.	Message	Appended with . . .
1	IN MEETING UNTIL	Time (when meeting done)
2	OUT UNTIL	Time (when returning)
3	OUT-PLEASE CALL	8 digits (phone number)
4	PLEASE CALL ME ON	8 digits (phone number)
5	BUSY CALL AFTER	8 digits
6	OUT FOR LUNCH BACK AT	Time (when returning)
7	BUSINESS TRIP UNTIL	Date (when returning)
8	BUSINESS TRIP CALL	8 digits (where reached)
9	GONE FOR THE DAY	
10	ON VACATION UNTIL	Date (when returning)
11-20	MESSAGE 11-20	



# Selectable Display Messages

To select a message:

1.  +   4.

**OR**



 (Call Forward to Device).

2.  3 + Message number (01-20).  
Use ▼  and  ▲ to scroll through the messages.
3. (Optional for messages 1-8 and 10) Dial the digits you want to append to the message.

*You can append messages 1-8 and 10 with digits (e.g., the time when you will be back). You enter the time in 24-hour format, but it displays in 12-hour format.*





4.  to select message and hang up (if you dialed \*4 in step 1).

To cancel a message:

1.  +   4.

**OR**

 (Call Forward to Device).

2.  3
3.  to hang up (if you dialed   4 in step 1).

# Selectable Ring Tones

If you work in an area where your extension is close to others, you may want to customize the way calls ring your phone. This will help you differentiate calls to your extension from calls to other extensions.

To change your extension's incoming ring tones:

1. + .
2. to set Intercom ring or to set outside line ring.  
*Transferred calls use the Intercom ring tone you select.*
3. Dial code for the ring pattern you want:  
1 = High pitch  
2 = Medium pitch  
3 = Low pitch
4. to hang up.

To listen to the incoming ring choices:

1. + .
2. to listen to Intercom ring or to listen to outside line ring.  
*For outside line ring, enter the tone you want to listen, and for the 384i only, this is followed by the Tenant Group (1-4).*
3. Dial code for the ring pattern you want to hear:  
1 = High pitch  
2 = Medium pitch  
3 = Low pitch
4. to hang up.

# Serial Call

---

Do you have a caller that wants to talk to a co-worker, but needs to consult with you when they are done? If so, use Serial Call. When you Transfer a call with Serial Call, it automatically returns to you as soon as the conversation with the Transfer destination ends. Assume for a moment that you are a Customer Service Representative talking to a customer that needs technical help. Since you want to be sure that the problem is solved, you need to talk to the customer when they are done with Tech Service. With Serial Call, you can send the call to your technical department and be assured that it will come back to you when they are through.

For other Transfer options, refer to the Transfer feature on page 118.

## To place a Serial Call:

1. Place or answer outside call.
2. **[HOLD]** + Co-worker's extension number.  
*Your co-worker must lift the handset to respond to your announcement.*
3. **[FUNCTION]** (Serial Call) but do not hang up.  
*When your co-worker hangs up the call, it returns as a live Transfer back to you.*



# Tandem Trunking

Tandem Trunking lets you set up a Conference with two outside callers and then drop out of the call - leaving the callers talking in an Unsupervised Conference. Once you drop out you are not part of the conversation. The Unsupervised Conference continues until either outside caller hangs up. Optionally, you can rejoin the Conference and end it whenever you choose.

If you are a dispatcher for outside service people, for example, you can use Tandem Trunking to put two of your service people in touch:

- Answer a call from one service person.
- Place a call to the second service person.
- Set up the line-to-line Conference.
- Drop out of the call.

There are two methods for setting up Tandem Trunking. Your Communications Manager can tell you which method is available to you.

## Method A

To make a line-to-line Conference:

1. Set up first outside call.

*This can be a call you placed or answered.*

2. Press .



3. Set up second outside call.

4. Press  twice.

*You now have a Conference between you and the two outside parties.*

5.  (Transfer).

**OR**

 +  .

*You drop out of the call and leave the outside callers talking to each other.*

*The line keys for the calls blink (green) as long as the Unsupervised*

# Tandem Trunking



To make a line-to-line Conference (Cont'd):

*Conference continues. If one of your outside callers hangs up, the Conference ends.*

To return to the tandem call:



1. Flashing .  
*You must have a line key to be able to rejoin the Conference. Press Transfer key or HOLD + #8 to reinstate the Conference.*  
*If one of the callers hangs up, you continue talking to the remaining caller.*

To end the line-to-line Conference:



1. Press flashing  to return to the Conference.
2.  to hang up.

## Method B (Requires a [Transfer] key)

To make a line-to-line Conference:

1. Set up first outside call.  
*This can be a call you placed or answered.*
2. Press .
3. Set up second outside call.
4. Press  (Transfer).  
*You drop out of the call and leave the outside callers talking to each other.*  
*The line keys light steadily for both outside parties.*





To end the line-to-line Conference:

1. Press  +  .
- This immediately disconnects the Conference.*

# Time and Date

You see the Time and Date on your telephone's display when it is idle. If you notice that the Time and Date are incorrect, you may be able to change them. Use some caution, however, since the Time and Date affect how your system routes calls and handles other features.

## To set the Time and Date:

1.  +   .
2. Dial the Time and Date password.  
*The password is normally 0000.*
3. Dial two digits for the year (e.g., 92).
4. Dial two digits for the month (01-12).
5. Dial two digits for the day (01-31).
6. Dial the day of the week (0-6).  
*0=Sunday, 6=Saturday*
7. Dial two digits for the hour (24 hour).  
*For example, 13=1:00 PM.*
8. Dial two digits for the minutes (00-60).  
*You hear confirmation beeps.*
9.  to hang up.

# Transfer

---

Transfer lets you quickly send the call you are on to a co-worker. You can Transfer both Intercom and outside calls. You can use the following types of Transfer:

<b>Screened Transfer</b>	Announce the call to your co-worker before hanging up. Use Screened Transfer when you're not sure your co-worker is in, or you think they might not want the call.
<b>Unscreened Transfer</b>	Transfer the call and hang up without announcing it. This is the quickest way to Transfer. Don't worry, the call will ring back to you if your co-worker doesn't pick it up.
<b>Extension (Department Group) Transfer</b>	Send the call to a Department Group instead of a co-worker's extension. Any idle extension within the group will get the call.
<b>Transfer Without Holding</b>	A co-worker presses a busy line key and waits for you to be done with the caller. They automatically get the call when you hang up. This is a fast way to Transfer if you share an office and you know who's on the line.
<b>Meet Me Paging Transfer</b>	Transfer a call to a Page zone rather than a co-worker's extension or Department Group. Use Meet Me Paging Transfer when you're not sure where your co-worker is.



If you want your transferred call to automatically come back to you when your co-worker hangs up, use Serial Call (page 114).

## Transferring Outside Calls

To Transfer a call to a co-worker's extension:



1.  *You hear Transfer dial tone.*
2. Dial co-worker's extension number.  
*If the extension is busy or doesn't answer, you can dial another extension number or press the flashing line key to return to the call. In addition, you may be able to hang up and have the call Camp-On.*
3. Announce call and hang up.  
*If you don't have Automatic On Hook Transfer, you must press CONF or your Transfer Programmable Function Key to Transfer the call.*  
*If your co-worker doesn't want the call, press the flashing line key to return to the call.*  
*If you don't want to screen the call, hang up without making an announcement.*

To answer a call transferred to your extension:

1.  or  when a co-worker announces the call.

## Transferring Without Holding

To Transfer Without Holding:

1.  (or ) + Busy .  
*When original caller hangs up, you connect.*

# Transfer

---

## Transferring Intercom Calls

### To Transfer your Intercom Call:

1. **HOLD** + Extension to receive your call.  
*If the extension is busy or doesn't answer, you can dial another extension number or press the flashing CALL key to return to the call. In addition, you may be able to hang up and have the call Camp-On.*

2. Announce call and hang up.

*If your co-worker doesn't want the call, press the flashing CALL key to return to it.*

#### **With Automatic On Hook Transfer**

*If your co-worker just speaks toward their phone to answer, the transferred Intercom call goes on hold at your phone when you hang up.*

#### **Without Automatic On Hook Transfer**

*You must press CONF or your Transfer Key to Transfer the call.*

*If your co-worker just speaks toward their phone to answer, the transferred Intercom call disconnects when you hang up.*

*To Transfer the call unscreened, press CONF or your Transfer key and hang up without making an announcement.*

## Meet Me External Paging Transfer

To make a Meet Me External Paging Transfer:

1. **HOLD**
2. **8** **0** **3** + External Paging code (1-8 or 0 for All Call).  
**OR**  
**FUNCTION** (External Paging Zone).  
**OR**  
Combined Paging Zone code (**\*** **1** + 0-8).
3. Announce Call.
4. When Paged party answers,  to Transfer call to them.

To join a Meet Me External Paging Transfer:

1. **CALL1** + **8** **6** **5** + Announced External Paging code (1-8 or 0 for All Call).  
*You connect to the Paging party.*
2. Stay on the line.  
*After the paging party hangs up, you connect to the transferred call.*

# Transfer

## Meet Me Internal Paging Transfer

To make a Meet Me Internal Paging Transfer:

1. **HOLD**
2. **8** <sup>TUV</sup> **0** <sup>OPER</sup> **1** + Internal Paging code (0-9 or 00-64).

**OR**

**FUNCTION** (Internal Paging Zone).

**OR**

Combined Paging Zone code (**\*** **1** + 0-8).

3. Announce Call.
4. When Paged party answers,  **HANG UP** to Transfer call to them.

To join a Meet Me Internal Paging Transfer:

1. **CALL1** + **8** <sup>TUV</sup> **6** <sup>MNO</sup> **3** <sup>DEF</sup> (if your extension is in the zone called).

**OR**

**CALL1** + **8** <sup>TUV</sup> **6** <sup>MNO</sup> **4** <sup>GHI</sup> + Zone number (0-9 or 00-64) (if your extension is not in the zone called).

**OR**

**CALL1** + **FUNCTION** (Internal Paging Zone Answer) (if your extension is in the zone called).

2. Stay on the line.



*After the Paging party hangs up, you connect to the transferred call.*



# Trunk Queuing and Camp On

When you try to place an outside call and hear busy tone from your own phone system, you don't have to hang up and try again later. Use Trunk Queuing to leave a request for the busy line to call you when it's free. Just answer when Trunk Queuing rings you back and dial your call again. If you prefer, use Trunk Camp On to wait for the busy line without hanging up. With Trunk Camp On, you'll be able to use the line the moment it's available.

To queue for a busy line:

1. Try to access outside line.  
*Listen for busy tone.*
2.  or  (Trunk Queuing).
3. Hang up to leave a Trunk Queuing request.





**OR**

Wait without hanging up for the line to become free.

To answer when Trunk Queuing calls you back:

1.  or .

To cancel a Trunk Queuing request:

1.  +    +  to hang up.



# Voice Announce Unit (VAU)

☞ This feature requires a Voice Announce Unit (VAU).



You can record the Voice Announce Unit (VAU) messages your system uses for Automated Attendant greetings (page 16) and the General Message (page 51). If your system has incoming 900 service, you can also record the message that plays to those callers before automatic billing occurs. You can record up to 16 separate messages, with a combined recording time of 128 seconds.

To record, listen to or erase a VAU Message:



1.  +    .

2. To record, dial  .

**OR**

To listen, dial  .

**OR**

To erase, dial  .

3. Dial the VAU message number (01-16) you want to record, listen to or erase.

*If recording, begin when you hear the announcement, "Please start recording." When done, press # to check what you recorded.*

*When listening to a message, press # to hear the message again.*

*If erasing, you can cancel erasing by pressing HOLD before hanging up.*

4.  to hang up.

 This feature requires an optional NVM-Series Voice Mail system.

Tired and frustrated by missed calls, inaccurately written messages and telephone tag? End these hassles with Integrated Voice Mail. Ask your Communications Manager if you have this type of Voice Mail system installed. Integrated Voice Mail enhances your phone by giving you:

<b>Call Forwarding to Voice Mail</b>	To have your incoming calls automatically go to your mailbox, forward your calls to Voice Mail. Your callers can leave a message instead of calling back later. You can have forwarding for all calls immediately, for unanswered calls, or for both unanswered calls and when your extension is busy. You can even have your phone emulate an answering machine (called Personal Answering Machine Emulation).
<b>Leaving a Message</b>	When you call a co-worker and their phone is unanswered, busy or in Do Not Disturb, you can easily leave a message in their mailbox. You don't have to call back later.
<b>Transferring to Voice Mail</b>	Transfer a call to your own or a co-worker's mailbox. After the Transfer goes through, your caller can leave a message in the mailbox.
<b>Conversation Record</b>	While on a call, press your Record key to record the conversation in your mailbox. Voice Mail stores the conversation like any other voice message. You can then save, edit or delete the recorded conversation.

# Voice Mail

---

## Calling Your Mailbox

To call your mailbox:

1. **[FUNCTION]** (Voice Mail).

**OR**

<sup>CALL1</sup>  
[ ] + [\*] <sup>TUV</sup>  
[8]

2. (Optional) After answer, dial security code.

*Ask your Communications Manager for your security code.*

## Leaving a Message

To leave a message in the mailbox of an unanswered extension:

*The extension you call can be busy, in DND or unanswered.*

1. **[FUNCTION]** (Voice Mail).

**OR**

<sup>TUV</sup>  
[8]

*The Voice Mail system will prompt you to leave a message.*

## Forwarding Calls to Your Mailbox



To activate or cancel Call Forwarding:

1. <sup>CALL1</sup>  
[ ] + [\*] <sup>ABC</sup>  
[2]

**OR**

1. **[FUNCTION]** (Call Forward to Station).
2. Dial Call Forwarding condition:
  - 2 = Busy or not answered
  - 4 = Immediate
  - 6 = Not answered
  - 0 = Cancel









## To activate or cancel Call Forwarding (Cont'd):

3. Dial Voice Mail master number or press Voice Mail key.
4. Dial Call Forwarding type:  
2 = All calls  
3 = Outside calls only  
4 = Intercom calls only
5.  to hang up (if you dialed   
 in step 1).

*Your DND or Call Forwarding Programmable Function Key flashes when Call Forwarding is activated.*

## Emulating a Personal Answering Machine

### To have your phone emulate a personal answering machine:

1.  +  .  
**OR**  
1.  (Call Forward to Station).  
*To cancel, dial 0 and skip to step 3.*
2.  + Dial Call Forwarding type:  
2 = All calls  
3 = Outside calls only  
4 = Intercom calls only
3.  to hang up (if you dialed   
 in step 1).

*Your DND or Call Forwarding (Station) Programmable Function Key flashes when Call Forwarding is activated.*

# Voice Mail

When Personal Answering Machine Emulation broadcasts your caller's voice, you can:

1. Do nothing and have Voice Mail automatically record your caller's message.



**OR**

Lift the handset to listen to the message in private.

**OR**

Press flashing  to intercept the call.

**OR**

Press idle  or  for a new call.

## Transferring Calls to a Mailbox

To Transfer your active call to a mailbox:

1. 
2.  (Voice Mail).

**OR**

Dial Voice Mail master number.

3. Number of mailbox to receive Transfer.

*This number can be your mailbox number or a co-worker's mailbox number.*

4.  to hang up.

## Recording Your Call

To record your active call in your mailbox:

1.  (Voice Mail Record).

*You hear two beeps and your Record key flashes. The beeps periodically remind you that you are recording.*

# Voice Over

If you need to get through to a co-worker busy on another call, press your Voice Over key. After the Voice Over alert tone ends you can talk to your busy associate. They can respond to you without their initial caller hearing. Your co-worker can even switch back and forth between you and their initial call. Your Voice Over key shows the feature's status:

When the key is . . .	You are . . .
Off	Not using Voice Over
Flashing (red)	Listening to the interrupting party
On (green)	Responding to the interrupting party

For other ways to get through to a busy co-worker, see Call Waiting (page 25), Callback (page 26), Off Hook Signaling (page 76), Message Waiting (page 68) and Voice Mail (page 125).

## To initiate a Voice Over to a busy co-worker:

*You can only leave a Voice Over if you hear two Off Hook Signaling tones.*

1. **IFUNCTION** (Voice Over) or **6**<sup>MNO</sup>.

*You hear the Voice Over alert tone and your Voice Over Key flashes. You can talk to your co-worker after the alert tone ends.*

## To answer a Voice Over you receive:

1. Press and hold flashing **IFUNCTION** (Voice Over).

*The Voice Over key lights (green) and then you can talk to the interrupting party. Note that you cannot respond by dialing the Voice Over feature code (6).*

## To return to your initial call:

1. Release **IFUNCTION** (Voice Over).

*You can press your Voice Over key repeatedly to switch between your initial call and the interrupting party.*

# Voice Prompting Messages

☞ This feature requires a Voice Announce Unit (VAU).

The voice prompts tell you about your system, your extension and the status of your call. The table below lists the most common voice prompts you may hear. Ask your Communications Manager if you need explanation of any other prompts.



<b>Voice Prompting Messages</b>	
<b>Message</b>	<b>This message will play when . . .</b>
This is station	You dial 6 for your extension number.
The date is	You dial 3 for the date.
The time is . . . The date is . . .	You dial 8 for the time (and date, depending on your software).
. . . is busy, for callback dial . . .	You call a busy extension.
All lines are busy, for callback dial	You try to place an outside call when all lines are busy.
Please do not disturb	You call a co-worker that has enabled Do Not Disturb.
The lowest cost line is busy, please wait for the next one	ARS tries to reroute your call and the least costly route is busy.
The number you have dialed is not in service	You dial a Service Code that Class of Service prevents.
You have a message	A co-worker has left you a Message Waiting.
Your call cannot go through, please call the operator	Toll Restriction has denied your call.
Your calls have been forwarded	You have enabled Call Forwarding.
Vacant number	You dial an extension that does not exist.





# Voice Prompting Messages

Voice Prompting Messages	
Message	This message will play when . . .
Is unavailable	An outside caller dials an extension through the Automated Attendant and the extension is busy.
Please start recording	You dial the code to record a VAU message or Personal Greeting.
Recording finished	You are recording a VAU message or Personal Greeting and have exceeded the maximum allowed recording length.
Audio file is full	There is no more space available in the VAU for storing messages.
To listen dial To erase dial To re-record dial	You are trying to record a VAU message or Personal Greeting and the recording already exists.



To check the system time from your extension:

1. Do not lift the handset or press .
2.  (for Time).

For Older Software:  
To check the system date from your extension:

1. Do not lift the handset or press .
2.  (for Date).

To check your extension number:

1. Do not lift the handset or press .
2.  (for Number).

# Volume Control

You can control the volume of incoming ringing, splash tone, Paging, Background Music, Handsfree and your handset. Some telephones have two separate volume controls: a slide switch on the left side for ringing and tones, and volume buttons for Background Music, Paging, Handsfree and the handset. Other telephones consolidate all adjustments into the volume buttons. Set them for their most comfortable level.

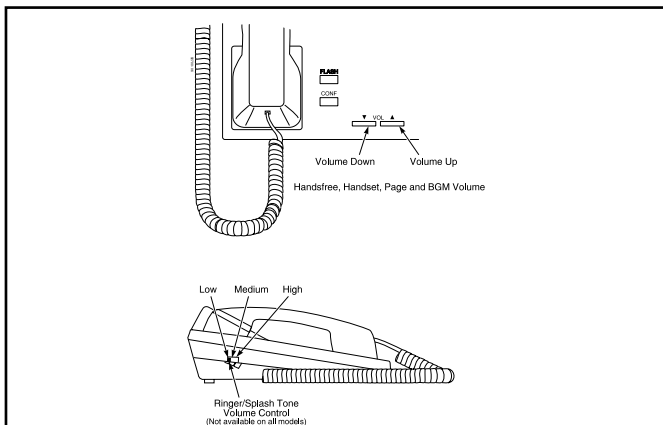

To adjust the volume of incoming ringing and splash tone:

1. Slide the control switch or ▼ **VOL** or **VOL** ▲ (if your phone doesn't have a control switch).

*If you have an i-Series phone (P/N 927.xx) you can press CHECK + Volume up or Volume Down to show the volume level.*

To adjust volume for incoming Paging, BGM, Handsfree and the handset or display contrast:

1. ▼ **VOL** or **VOL** ▲.

*You can press these keys while on a call or while idle. For i-Series phones, the feature must be active, otherwise the display's contrast is changed (except on super display phones).*

# Charts and Illustrations

---

This section contains handy charts and illustrations for your reference.

- The dialing plan (the numbers you dial) - see the following chart.
- Super Display Telephone key layout (inside back cover).
- Multibutton Telephone key layout (inside front cover).
- DSS Console key layout (page 136).

## **Your System's Dialing Plan**

Due to the flexibility built into the system, your dialing codes or feature capacities may differ from those in this guide. Check with your Communications Manager and note differences in the Revised Codes column on the following pages.

# Charts and Illustrations

System Number Plan/Capacities								
System Type:	28i	28i Commonized	124i Commonized	124i	124i Enhanced	384i	704i	Your Revised Codes
Abbreviated Dialing: Abbreviated Dialing Groups	8	8	8	8	16	32	64	
Abbreviated Dialing Bins	360	1000	1000	360	1000	1990	2000	
Common Abbreviated Dialing Bins	200	200	500	200	1000	1000	1000	
Account Codes: Verifiable Account Code Table	1000	1000	1000	1000	1000	1000	2000	
Call Pickup Group Numbers	1-8	1-8	1-8	1-8	1-9 or 01-64	1-9 or 01-32	1-9 or 01-64	
Caller ID Bins	200 (0-199)	200 (0-199)	200 (0-199)	200 (0-199)	400 (0-399)	1000 (0-999)	1000 (0-999)	
Conference Circuits	8 4-Party 4 8-Party	8 4-Party 4 8-Party	8 4-Party 4 8-Party	8 4-Party 4 8-Party	8 4-Party 4 8-Party	32 4-Party 16 8-Party	32 4-Party 16 8-Party	
Department (Extension) Group Numbers	1-8	1-8	1-8	1-8	1-16	1-32	1-64	
Department (Extension) Group Number Range	200-799	200-799	200-799	200-799	200-799	200-799	200-799	
Door Box Numbers	1-8	1-8	1-8	1-8	1-8	1-8	1-8	
Extension Port Numbers	1-20	1-20	1-72	1-72	1-200	1-256	1-640	
Extension Number Range	301-799	301-799	301-799	301-799	301-548	301-799	301-499 5000-5696	

# Charts and Illustrations

System Number Plan/Capacities								
System Type:	28i	28i Commonized	124i Commonized	124i	124i Enhanced	384i	704i	Your Revised Codes
Operator Access	0	0	0	0	0	0	0	0
Paging: External/Combined Page Zones	0-8	0-8	0-8	0-8	0-8	0-8	0-8	
Internal Page Zones	0-8	0-8	0-8	0-8	0-9 or 00-16	0-9 or 00-32	0-9 or 00-64	
Park Orbits	1-8	01-32	01-32	1-8	01-32	01-32	01-64	
Tenant Groups	-	-	-	-	-	4	-	
Trunk Port Number	01-16	01-16	01-52	01-52	01-52	001-128	001-192	
Trunk Group Numbers	1-16	1-16	1-16	1-16	1-26	1-128	1-96	
Virtual Extension Port Numbers	73-96	73-96	73-96	73-96	201-248	257-384	641-896	
Virtual Extension Number Range	301-799	301-799	301-799	301-799	501-548	301-799	5441-5696	

# Charts and Illustrations

## Your DSS Console

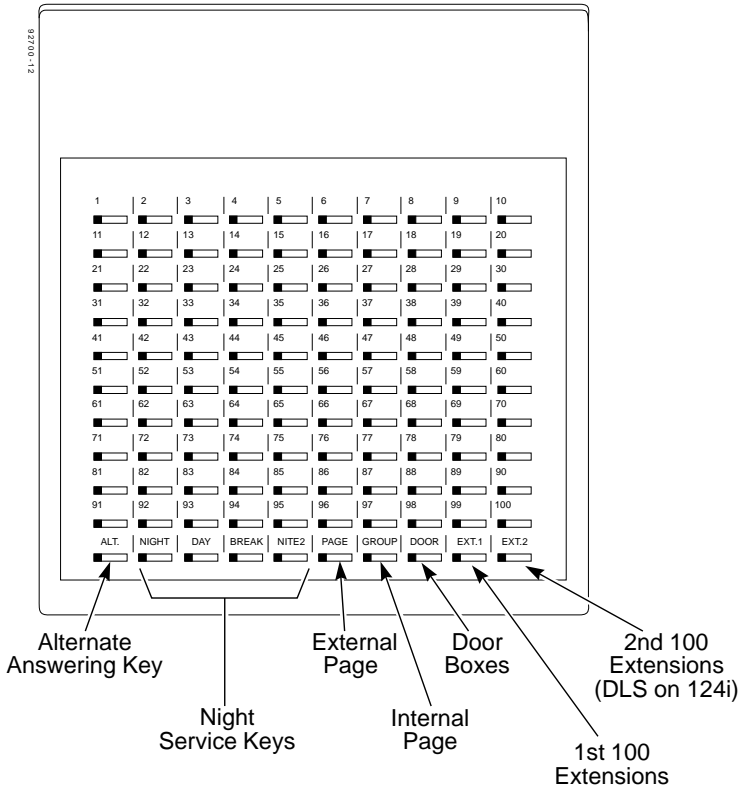

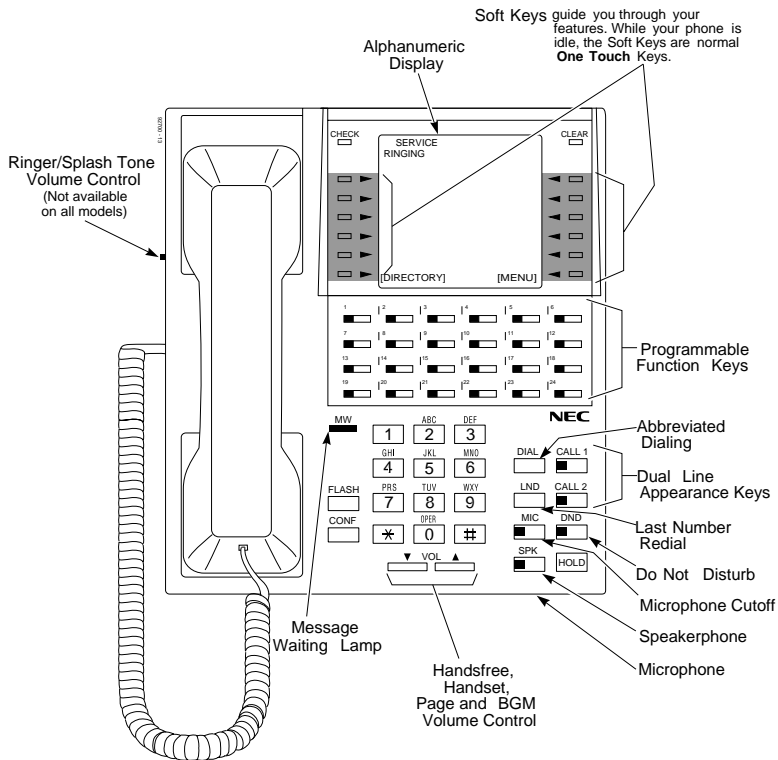

# NEC

NEC America Inc., Corporate Networks Group  
4 Forest Parkway, Shelton, CT 06484  
TEL: 203-926-5400 FAX: 203-929-0535  
[cng.nec.com](http://cng.nec.com)



92600MFH06

July 2002  
Printed in U.S.A.